

Issue One

THE

2017

ICELANDIC HORSE

Q U A R T E R L Y



Official Publication of the United States Icelandic Horse Congress
Member Association of FEIF (International Federation of Icelandic Horse Associations)



TÖLT TACK

THE U.S. SUPPLIER OF ICELANDIC TACK

PROUD TO REPRESENT



TÖLT TACK is here to serve the Icelandic Horse community with the best quality, value and service possible. See the website for the full line of superior products and services available.

STIRRUPS · BRIDLES · GIRTHS · GROOMING · VIDEOS · BOOKS



INFO@TOLTTACK.COM - 541 490 0975

WWW.TOLTTACK.COM



RED FEATHER ICELANDICS

*IN THE BEAUTIFUL CASCADE MOUNTAIN RANGE
OF THE PACIFIC NORTH WEST*



OUR 2017 CLINIC SCHEDULE

APRIL 29 & 30

GUÐMAR ÞOR PETURSSON

JUNE 23 THRU 26

ARNAR BJARKI SIGURÐARSON

SEPTEMBER 15 THRU 17

**EYJOLFUR ISOLFSSON
JOLLI**

OCTOBER 28 & 29

TRAUSTI ÞOR GUÐMUNDSSON

FULL ICELANDIC FACILITY

SALES - LESSONS - TRAINING

BOARDING - BREEDING

CLINICS - TACK

CONTACT US TO SECURE YOUR CLINIC SPOT

WWW.REDFEATHERICELANDICS.COM

Dick and Linda Templeton

linda@redfeathericelandics.com - 541-490-0975

Alexandra Dannenmann

IPZV Trainer B

FEIF International Sport Judge

lessons • training • boarding • clinics



www.floridaicehorsefarm.com • floridaicehorsefarm@gmail.com • 239-223-5403

The Talent To Win

The Temperament To Enjoy The Journey

ASLAN'S COUNTRY



ICELANDICS

Álfadans frá Ingólfshvoli

Internationally known for his success in competition and as a proven sire noted for stamping his progeny with elasticity, superior movement, rideability, and exceptional temperament



Specializing in the breeding and development of top quality performance and pleasure horses. Numerous well-bred and properly developed horses for sale.

Kydee Sheetz 5380 Ugstad Junction, Proctor, Minnesota | acicelandics@yahoo.com | 218-349-2209



WHY REGISTER YOUR HORSE WITH THE USIHC?

Photo by Martina Gates

Proof of ownership

Registering your horse is proof of ownership, like the title for your car. If the horse you buy is already registered with the USIHC, it means it is registered in the previous owner's name, both in the U.S. and in the worldwide database WorldFengur. In order to transfer ownership to you, the previous owner and you just need to sign the registration papers and send them to the USIHC Registrar. You will receive new papers—proving you are the new owner—in the mail shortly.

Proof of pure breed

Registration is proof that your horse is a purebred Icelandic, and that increases the value of your horse. All registered horses are DNA typed. This is especially important if your horse is a mare or stallion.

Participation

Some USIHC programs and events require the horse to be registered, such as the Pleasure Rider Program, the Ambassador Program, the World Championship tryouts, FEIF Youth Cup tryouts, American Youth Cup tryouts, and inclusion in the USIHC Stallion book. Registration keeps the international Icelandic horse database, WorldFengur, accurate and complete. Not only stallions and mares, but also geldings need to be registered for a full offspring record. The Icelandic horse community and breeders worldwide depend on this source of information, a model that other breed organizations do not have.

How to Register

Registering your horse costs only between \$15 and \$50. A surcharge of \$25 is due for non-USIHC members. The Registry Rules and all forms needed are available at www.icelandics.org, the Congress website. Or contact the Registrar, Ásta Covert, at registry@icelandics.org or 866-929-0009.

Support the Icelandic horse nationally and internationally—register your horse with the USIHC!

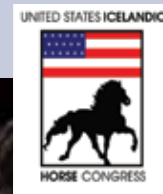

THE USIHC MISSION

- To promote the knowledge of the Icelandic horse within the United States and its correct use as a competition and riding horse.
- To keep a registry of purebred Icelandic horses in the United States.
- To facilitate communication among all USIHC members.
- To represent the United States in FEIF.

The U.S. Icelandic Horse Congress is a member of FEIF (www.feif.org), the International Federation of Icelandic Horse Associations, representing the national Icelandic horse associations of 19 countries. FEIF governs competition activities and regulates the breeding and registration of Icelandic horses throughout the world outside of Iceland.

The USIHC was formed in 1987 by representatives of the U.S. Icelandic Horse Federation and the International Icelandic Horse Association to meet the FEIF rule that only one association from each country is allowed to represent the breed.

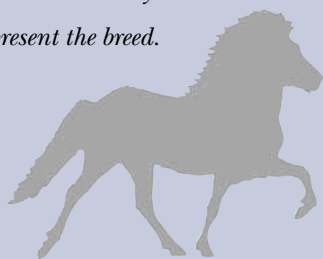

Photo by Martina Gates

LEARN

As the owner or rider of an Icelandic horse, you chose a very special breed with its own culture and history. It is important to learn about the breed's unique traits, capabilities, and needs, so that you and your Icelandic horse will have a happy relationship and it will live a healthy and long life in a country far from its origin. As a USIHC member, you have a wealth of information at your fingertips and a personal connection to the best experts in the country.

You receive *The Icelandic Horse Quarterly*, a 52-page all-color magazine, four times a year. All issues since 2008 are indexed and available online.

You have free access to WorldFengur, the worldwide database of all registered Icelandic horses. About 450,000 horses, alive and deceased, are included, with pedigrees, offspring, ownership, and evaluation and competition results. Some horses even have photos and videos. WorldFengur is an invaluable tool for all Icelandic horse breeders and very interesting for the rest of us. Go to "Search Horses" on the USIHC website and find any US-registered Icelandic horse by its number, name, or farm name to link to WorldFengur.

You can take part in—and even help create—educational seminars and teaching programs. For example, the USIHC Education committee developed and now administers the Riding Badge Program for pleasure and competition riders of all ages. On the USIHC website you can find links to certified trainers who are USIHC members and can help you get the best out of your Icelandic horse. The Education Committee also offers Sport Judges Seminars for those wanting to learn more about show rules and how to judge competitions. A \$1,000 grant is available to members who complete their certification to become national or international judges.

The USIHC also has a scholarship fund for members who complete their certification to become national or international judges.

CONNECT

Icelandic horses are social animals, and so are their people. The USIHC is the umbrella organization of Regional Clubs all over the U.S.: There are currently 13 active clubs. Find the regional Icelandic riding club in your area through the USIHC website, so that you and your horse can

ride with friends. The USIHC Board has set aside funding for regional clubs to host clinics, schooling shows, sanctioned shows, young horse evaluations, and full breeding shows.

USIHC Youth members can apply to participate in the American Youth Cup or the international FEIF Youth Cup or Youth Camp. These are great events designed to bring young riders together for a week of fun, learning, and competition.

Through the USIHC website, you can sign up for RSS feeds for the Events Calendar or web updates. You can check the membership list to see if your friends are members and when your own membership expires. And you can stay connected through the USIHC Facebook page.

COMPETE

The Icelandic horse has international competition rules: You can compete in the same classes and under the same rules in any of the 19 FEIF member countries and compare your progress with competition riders from around the world.

The USIHC Competition committee adapts these international FEIF rules for American venues and special circumstances, publishing a new set of USIHC Competition Rules each year. These are available on the USIHC website, along with all the tools needed to put on a sanctioned show, such as entry forms, judging forms, judges' cards, and announcers' cards. (These tools are also useful for organizing fun shows and schooling shows.) Also on the website are lists of recommended and prohibited tack and equipment, track sizes, and other information for competition riders.

Sanctioned shows and schooling shows are eligible for USIHC Funding; contact the Competition committee. Show organizers have access to the IceTest software so that eligible scores immediately appear in the U.S. National Ranking; qualified shows can also send scores to the FEIF World Ranking list. Scores are posted on the USIHC website for everyone to see and compare.

Only USIHC members can join the U.S. team at the Icelandic Horse World Championships, held in a FEIF country every other year. If you hope to compete at an international level, see the team recommendations and requirements on the USIHC website. Tryouts for the team are open and are National Ranking events: Anyone can ride for scores and to get feed-

back from an international judge, whether or not you intend to compete in the World Championships.

PROMOTE

USIHC members promote the Icelandic horse at many equine expositions around the country. The USIHC provides display materials, including brochures and copies of the *Quarterly*. The USIHC Breed Ambassador program rewards members who take their Icelandic horses to all-breed events and shows.

Trainers, breeding farms, and trekking barns can promote their services through the USIHC Farm List in the *Quarterly* and on the website. Stallion owners can promote their stud services through the online USIHC Stallion Book.

And everybody, members or nonmembers, can advertise in the *Quarterly*.

REGISTER

Whether you plan to breed one mare or have a breeding farm, the USIHC Registry and the Breeding committee provide information and services to help you. The Icelandic horse is one of few breeds with international evaluation standards, so that breeding horses from all over the world are judged on the same 10 points of conformation and 10 points of ridden abilities, and all scores are entered into the WorldFengur database. That allows you to compare the quality of your breeding stock with Icelandic horses around the world, both past and present.

USIHC-sanctioned breeding evaluation shows for registered adult horses ages four and up are scheduled by USIHC Regional Clubs and private farms. Breeding shows and seminars are eligible for USIHC funding. All rules and regulations are supplied by the Breeding committee from the international FEIF rules and are available on the USIHC website. Regional Clubs and private farms can also organize Young Horse Assessments for foals to three-year-olds. These assessments also qualify for USIHC funding; contact the Breeding Leader.

In accordance with FEIF rules, the

USIHC has adopted stringent tests before a foal can be registered as a purebred Icelandic horse. You can be sure of the parentage of any registered Icelandic horse and know that your registered foals have proof of their value.

You don't have to be a USIHC member to register your Icelandic horse, but by becoming a member you help support this vital USIHC program.

INNOVATE

The USIHC is a member-driven organization. The more active and involved our members are, the stronger the USIHC becomes. Do you have an idea for a project or event that will support the Icelandic horse in America?

Requests for funding for special events and programs can be submitted to the USIHC board of directors and will be reviewed on a case-by-case basis. Contact the USIHC president for more information.

JOIN US

There are only about 5,800 registered Icelandic horses in the U.S. and the USIHC, at about 625 members, is still a small "pioneer" organization compared to our counterparts in Iceland and Germany. Our committee members and board of directors are all volunteers. Please join us so that the USIHC can, as FEIF's mission states, "bring people together in their passion for the Icelandic horse"!

Yearly membership for an adult is \$45; youth memberships are \$35; or for a family (two adults, unlimited kids) it is \$65. Mail in the form in this magazine or join online at www.icelandics.org/join

QUESTIONS?

USIHC Board members and Committee chairs are here to answer them. For general questions, call or email our information desk or check the website.

Toll free: 866-929-0009
info@icelandics.org
www.icelandics.org

FEIF'S MISSION: FEIF BRINGS PEOPLE TOGETHER
IN THEIR PASSION FOR THE ICELANDIC HORSE



ICELANDIC HORSE

Q U A R T E R L Y

Official Publication of the United States Icelandic Horse Congress (USIHC), a member association of FEIF (International Federation of Icelandic Horse Associations).

©2017 All rights reserved.

The Icelandic Horse Quarterly is published in March, June, September, and December by the USIHC as a benefit of membership. Renew online at www.icelandics.org.

Deadlines are January 1 (for the March issue), April 1, July 1, and October 1. We reserve the right to edit submissions. All articles represent the opinions of their authors alone; publication in the *Quarterly* does not imply an endorsement of any kind by the USIHC. Ads are accepted with the understanding that the advertiser is authorized to publish their contents and agrees to indemnify the USIHC and the *Quarterly* against any loss or expense resulting from their publication. The USIHC reserves the right to reject any ad.

Quarterly Committee:

Carol Andrew, Margot Apple, Heidi Benson, Andrea Brodie, Karen Brotzman, Nancy Marie Brown (co-editor), Juli Cole, Nicki Esdom (co-editor), Eileen Gunipero, Connie Kollmann, Maike Liekweg, Gabriele Meyer, Anne Owen, Sali Peterson, Alex Pregitzer, Chris Romano, Judy Strehler, Nancy Wines-Dewan, Lynn Wiese

Advertising: Jean Ervasti (917-648-8824 or jjjervasti@hotmail.com)

Graphic Design: James Collins

On the cover: Dan Riva riding Fjalar frá Bjargshóli (US90101810) with “a fair amount of intensity,” as Barb Riva puts it, at the 2015 Flugnirkeppni, the annual USIHC-sanctioned show sponsored by the Flugnir Regional Club and held at the Riva’s Winter-horse Park in Eagle, WI. The reason for such intense concentration? Dan was trying to beat his 12-year-old grandson, Jay Maio, in Tölt T3. Fjalar, a 25-year-old stallion, looks entirely happy to go along with the plan but, sadly, they came in second. Photo by Ryan Young.

10 NEWS

- 9 USIHC News
- 13 FEIF News
- 15 Regional Club Updates

26 FEATURES

- 26 Driving Your Icelandic *by Nancy Wines-Dewan*
- 30 An Almost Free Horse *by Liz Stimmler*
- 32 WorldFengur 101: Part 2 *by Martina Gates*
- 37 Blood Research: Update *by Tracy Stokol and Bettina Wagner*
- 38 Champions of the East *by Jess Haynsworth*

USIHC CONTACTS

Committees

Breeding@icelandics.org
Kydee Sheetz (218-349-2209)

Competition@icelandics.org
Asta Covert (805-688-1393)

Education@icelandics.org
Alex Dannenmann (239-223-5403)

Leisure_riding@icelandics.org
Lisa McKeen (360-398-3036)

Promotion@icelandics.org
Juli Cole (724-667-4184)

Quarterly@icelandics.org
Nancy Brown (802-626-4220)
Nicki Esdom (914-826-5159)

Regional_clubs@icelandics.org
Leslie Chambers (860-334-8259)

Youth@icelandics.org
Kelly Blough (408-354-7183)

Directors

president@icelandics.org
Will Covert (805-688-1393)

vice_president@icelandics.org
Lori Cretney (262-495-8745)

secretary@icelandics.org
Doug Smith (831-238-3254)

treasurer@icelandics.org
Kari Pietsch-Wangard
(414-322-3214)

Andrea Barber
(tolstar@yahoo.com)

Leslie Chambers
(lchambers17@comcast.net)

Alexandra Dannenmann
(239-223-5403)

Jessica Haynsworth
(617-962-0065)

Linda Templeton
(541-490-0975)

Registry

c/o Ásta Covert
P.O. Box 1724
Santa Ynez, CA 93460
Toll free: 866-929-0009
registry@icelandics.org

Main Office

United States Icelandic
Horse Congress
c/o Kari Pietsch-Wangard
300 South Sawyer Road
Oconomowoc, WI 53066
Toll free: 866-929-0009
info@icelandics.org

Website

c/o Doug Smith
www.icelandics.org
webhelp@icelandics.org

ANNUAL MEETING

The 2017 USIHC Annual Meeting was held on January 14 in Pittsburgh, PA. The meeting was hosted by the Ohio Valley Icelandic Horse Club. Seven members of the Board of Directors attended, including president Will Covert, vice president Lori Cretney, treasurer Kari Pietsch-Wangard, secretary Doug Smith (who, although he had declined to stand for reelection in 2016, was reappointed to the board by the other directors), Leslie Chambers, and newly elected board members Alexandra Dannenmann and Jessica Haynsworth; Andrea Barber and Linda Templeton, the third new board member, did not attend. Also at the meeting were Registrar Asta Covert, Promotion committee chair Juli Cole, and Quarterly committee co-chair Nancy Marie Brown. Year-end reports were presented by the

treasurer and registrar; by representatives of the breeding, education, promotion, Quarterly, regional clubs, and sport committees; and for the Blood Profile Project. Highlights of the reports and meeting discussion follow; the full reports can be read on the USIHC website at www.icelandics.org/bod/2016AnnualReports.pdf. For bios of the new three board members, see Issue Four 2016 of the *Quarterly*.

TREASURER'S REPORT

In step with the board's plan to draw down the USIHC's funds to "invest in the future," the Congress ended the year with about a 4 percent loss. The USIHC's major expenses for 2016 came from the *Quarterly*, USIHC-sanctioned shows, the Blood Profile Project, Regional Club clinics, youth programs, and the Registry. Most, if not all, of the \$5,000 seed grant

for the Blood Profile Project will be refunded when the study is complete and its full expenses are known, since donations from individual members exceeded the funds needed.

BREEDING REPORT

The Caryn Cantella Award for the highest evaluated young horse bred in the U.S. goes to breeding leader Kydee Sheetz of Aslan's Country Icelandics in Proctor, MN for her young red dun stallion Álfagaldur from Aslan's Country (US2016105113). (See the article in Issue Four 2016 of the *Quarterly*.)

Two Young Horse Evaluations are planned for 2017, but as of January no full Breeding Horse Evaluations have been scheduled. To help revitalize this critically important program, the Breeding Committee is working with several



The Tölt T1 finals victory lap at the 2016 Kentucky Show (left to right): Guðmar Pétursson on Veigar frá Lækjamóti, Carrie Lyons-Brandt on Dropi frá Blönduósi, and Sigrún Brynjarsdóttir on Parkur frá Sólheimum. Photo by Susy Oliver.



Youth member Alicia Flanigan took fourth place in the A finals in Tölt T3 at the 2016 FEIF Youth Cup in the Netherlands. Photo by Krijn Buijtelaar.

farms to plan educational sessions by international breeding judges to prepare for a Breeding Evaluation Series in 2018.

The committee is also developing new programs to reach out to professional riders and breeders from other disciplines, to educate potential buyers, and to support a breeders' club.

EDUCATION REPORT

The long-awaited instructional materials for the USIHC Riding Badge Program have been completed and will soon be posted on the USIHC website. After a lengthy discussion of the purpose and goals of the program, all agreed that its name might change to make it more attractive to adult, as well as youth, riders; the committee and board will also consider making the instructional materials freely available on the USIHC website, instead of being restricted to members only. Sale of a printed version was also discussed.

A suggestion for the USIHC to provide support for each Regional Club to hold a Riding Badge clinic each year led to a discussion of the existing Regional

Club Clinic Funding project, which would cover such an idea.

In 2016 four Basic Level 2 Riding Badges were awarded following a course organized by Bernie Willis of the Alaska Icelandic Horse Association; the examiner was Janet Mulder. Badges were awarded to Frank Sihler, Claudie Sihler, Susan Dent, and Stefanie Flynn.

Another Education project completed this year was the translation from German of the instructional materials for the IPZV trainer level 1 course. Holding a FEIF trainer level 1 seminar (using the newly translated materials) or a lower-level seminar for riding instructors was discussed; Virginia Lauridsen of Iowa volunteered to host either type of seminar in 2017. The Education committee will review and revise its 2016 proposal, which was rejected by the board, to develop a U.S. instructor education seminar.

Finally, a Sport Judge Seminar with Þorgeir Guðlaugsson will be held at Thor Icelandics in Claverack, NY from April 20-23 2017. Þorgeir is a highly experienced and qualified FEIF international Sport Judge and has judged more World

Championships than any other judge. His enthusiasm about the subject makes him easy to listen to and enables participants at all levels to improve their knowledge. The seminar is open to anyone interested in the different gaits of the Icelandic horse, recognition of beat or balance problems and ideas on how to solve them, the assessment of gaits, and how to judge horse shows. The seminar includes lectures, video presentations, and practical judging. A voluntary test at the end of the seminar will be offered in order to qualify as an U.S. intern judge. Cost: \$400 for the seminar, \$50 for testing. Contact Education chair Alex Dannenmann at alex.dannenmann@gmail.com for more information.

PROMOTION REPORT

The 20 entrants for the 2016 USIHC Breed Ambassador Awards participated in a wide variety of events, including trail obstacle courses, mounted archery, field trials, driving events, clinics, and parades. These five winners were randomly drawn at the meeting and will each receive a t-shirt and \$50 gift card:

Jackie Alschuler and Leó frá Steinnesi participated in the Long Lake Hounds'



Susy Oliver riding Keli from Tolthaven in Tölt T5 at the 2016 Kentucky Show. Photo by Guðmundur (Mummi) Skúlason.



Jackie Alschuler and Leó frá Steinnesi (at right) won a 2016 Breed Ambassador Award for taking part in the Long Lake Hounds' Hunter Pace, an all-breed event in Hamel, MN. With her is Rachael Walker riding Jeanne Lyke's horse Hugar.

Hunter Pace in Hamel, MN.

Alice Ryan and Hrollur frá Grimsey participated in a 26-horse 15-mile scavenger hunt in Hartland, VT.

Melanie Stabler and Elgur from Twisted E participated in the Penny Underwood Gaited Dressage clinic in Michigan.

Nancy Wines-Dewan drove Brenna from Ice Follies in an all-breed Driving Derby at Spurwink Farm in Maine. (See her article on driving in this issue.)

Jessica Zamboni and Birting from Schmalztopf competed in an all breed Trail Horse Challenge.

Meeting participants also discussed the promotional value of having an Icelandic horse presence at such events as Equine Affaire. While the NEIHC has had great success at Equine Affaire in Massachusetts, the FIRC found that sponsoring a booth at expos in Pennsylvania and Maryland was not worth the cost and effort. In California, contact with the horses is restricted; some expos in the midwest have more liberal policies.

Each Regional Club, it seems, must figure out what works best in its area. The USIHC will, however, provide brochures and copies of the *Quarterly* to give out.

QUARTERLY MAGAZINE REPORT

Producing the *Quarterly* was compared to riding good tölt, as described by Nicki Esdorn in "Tölt 101" (from Issue Two 2016): "Riding good tölt starts with the rider's attitude. You need to mirror what you want to see in your horse: a happy, lively energy, a good mood, and willingness to go forward." A slideshow of highlights from the year's magazines can be watched on the USIHC Facebook page or on YouTube at <https://youtu.be/z2ywHWT8P6o>.

Informed by the results of our 2015 readers' survey the committee focused in 2016 on commissioning articles about training and riding by professionals. USIHC News, FEIF News, and Regional Club updates accounted for nearly 50 percent of the pages printed. This year the committee also reached a longtime goal of indexing the online archive.

The winner of the USIHC's yearly Spaeri Youth Essay Award, a collaboration between the Quarterly Committee and the Youth Committee, is seven-year-old Arianna De Forge, who trains in Vermont with Jessica Haynsworth. Arianna's story will be printed in an upcoming issue of the *Quarterly*.

REGIONAL CLUB REPORT

The 2016 Regional Club Clinic Funding project made \$500 available to each regional club to help fund a clinic that best served club members. Eight clubs this year brought in a variety of clinicians; all were recognized Icelandic horse specialists, including Marlise Grimm, Trausti Þor Guðmundsson, Nicole Kempf, Linda Pétursdóttir, Guðmar Pétursson, and Freya Sturm. Clubs participating in the program were Alaska, Flugnir, FIRC, Hestafolk, Klettafjalla, NEIHC, NWIHC, and St Skutla. For 2017, the committee is requesting additional funds so that each club can sponsor two clinics.

REGISTRY REPORT

In 2016, a total of 76 horses were registered, and the registrations of 157 horses were transferred. For domestic bred horses, 17 mares, 20 stallions, and 1 gelding were under 12 months old; 7



Jessica Zamboni and Birting from Schmalztopf won a 2016 Breed Ambassador Award for competing in an all-breed Trail Horse Challenge.

mares, 1 stallion, and 3 geldings were over 12 months. For imported horses, 10 mares, 2 stallions, and 7 geldings were from Iceland; 2 mares, 1 stallion, and 3 geldings were from Canada; and 1 mare and 1 gelding came from other countries. Total domestic horses in the USIHC registry equals 3,179, while imported horses equals 2,674, for a combined total number of U.S. horses registered in WorldFengur of 5,853.

SPORT

Including the Youth Cup tryouts, which were judged by video, 9 USIHC-sanctioned shows were held in 2016: 3 in California, 2 in Kentucky, 1 in Virginia, 1 in New York, and 1 in Wisconsin. Award Winners in the National Ranking, with their scores in parentheses, are: Asta Covert in T1 (7.35), T2 (7.40), and V1 (7.55); Laurie Prestine in T3 (6.45); Alexandra Venable in T4 (5.95); Elizabeth Robertson and Alicia Flanigan tied in T5 (5.90); Jessica Blough in T6 (6.40) and V3 (6.05); Hannah Bailey in T7 (5.75); Alicia Flanigan in T8 (5.70); Kathy Love in V2 (6.35); Jess Berman V5 (5.28); Alicia Flanigan in V6 (6.03); Terral Hill in F1 (6.45); and Gabrielle Pittman in F2 (4.69).

The first show of 2017 will be the CIA Open Spring Show on April 29-30. The Lettleiki Show and the NEIHC Open are

planned for June, and a World Ranking Show in Kentucky for October. Watch the USIHC Calendar at www.icelandics.org for more information.

YOUTH

Inspired by the successful 2015 American Youth Cup, a record number of young riders applied to participate in the 2016 FEIF Youth Cup. Four riders and team leader Kevin Draeger represented the USIHC in the Netherlands. They borrowed horses from Jaap and Yvonne Groven and trained at the Groven's farm, Stoerj van't Ilperveld in Den Ilp, also helping out there with the haymaking.

The Youth Committee is now preparing for the 2017 American Youth Cup, to take place at Coast Road Stables in Santa Cruz, CA from June 25 to July 2. The University of California at Santa Cruz has offered the use of facilities for lodging and meals, making the event both convenient and cost-effective for many youth to participate. The organizers are now recruiting horses and trainers for the event; publicity to encourage applicants should begin shortly. We hope to have as successful an event in 2017 as we did in 2015.

BLOOD PROFILE PROJECT

Over the summer, blood samples were collected from 121 Icelandic horses from around the country. Thanks to

the following farms and individuals, as well as to their local veterinarians, who provided their services at no cost to the project: Cornell University, NY; Creekside Farm, GA; Florida Icehorsefarm, FL; Gloria Verrecchio and clients in NC and SC; Lettleiki Icelandics, KY; Lone Cedar Icelandics, WA; Sand Meadow Farm, NY; and Winterhorse Park, WI. Many individuals also answered our call to donate funds to the project (see the advertisement in this issue).

Cornell started testing the samples as soon as they received them, and testing continued into the winter. Though many of these tests are usually just run through a machine, for the study to be most accurate some are also being checked under the microscope by hand. Getting the final results from all 121 samples will take some time. At the end of this phase we will know if we need any additional samples, due to problems with samples already received.

Once the data collection is complete, researchers Bettina Wagner and Tracy Stokol will begin analyzing the data and drawing conclusions. We hope to have final results by the end of 2017. For more information, contact Andrea Barber at bproject@icelandics.org.



Seven-year-old Arianna De Forge of Vermont won this year's Spaeri Youth Essay Award. Arianna's story will be printed in an upcoming issue of the *Quarterly*.

BOARD MEETINGS

The USIHC Board of Directors met on October 18, November 15, and January 14. Meeting minutes can be found online at www.icelandics.org/bod/minutes.php. The agenda for each meeting is announced on the USIHC website the weekend before. All USIHC members are invited to listen to the conference call; the phone number is included on the agenda.

In October, the Board discussed the September Sport Judge Seminar. Eight people participated and six took the test to become a judge. "Although nobody passed this time," noted Education leader Alex Dannenmann, "it was a good atmosphere and a great learning experience for all." Funding for the April seminar was approved; a screen and projector will be purchased for future seminars.

The Board voted to use surplus funds donated to the Blood Profile Project for additional testing; some funds will still be refunded to the USIHC.

A change to the Registry Rules (Section 14) was unanimously approved. According to the new rule, "Within 30 days of the date of initial registration breeder's suffixes may be changed for horses 3 years of age and under."

In November, Ásta Covert was appointed to temporarily replace Will Covert as USIHC Sport Leader while Will fulfills his duties for the 2017 FEIF World Championships.

In January, the Board elected officers and appointed Board liaisons to the committees, including Breeding (Will Covert), Education (Alex Dannenmann), Leisure (Linda Templeton), Promotion (Kari Piestch-Wangard), Quarterly and Regional Clubs (Leslie Chambers), Sport (Jess Haynsworth), and Youth (Lori Cretney).

The Board approved publication of the Riding Badge Materials, deciding to publish the materials exclusively in print via the self-publishing website MagCloud with no markup. Based on current pricing an interested person can order a copy of the materials for \$13.00 plus \$5.33 in postage. Volume discounts apply for larger purchases.



WORLD CHAMPIONSHIPS

The Sport judges for the 2017 World Championships have been selected from a record-setting pool of 30 willing judges. The selection committee consisted of Þorgeir Guðlaugsson (World Championships Chief Judge), Doug Smith (FEIF Director of Sport), and Will Covert (designated by the FEIF Sport Judges Committee).

The selection process considered the activity of each potential judge during the 2016 competition season, the limits on the number of judges from the same country, the need to bring fresh judges to the World Championships, and the committee's opinions about which individuals would make the strongest overall jury.

The jury for the World Championships 2017 will consist of (in alphabetical order): Andre Boehme, Anna Andersen, Åsa William, Einar Ragnarsson, Halldór Gunnar Victorsson, Johannes Hoyos, Lisa Olovsson, Lutz Lesener, Rune Svendsen, Sigurbjörn Viktorsson, Stefan Hackauf, Uschi Heller-Voigt, and Valdimar Auðunsson. The reserve judges are Christian Reischauer and Nicolai Thy.

YOUTH CAMP

The 17th international FEIF Youth Camp will be held in Sint-Truiden, Belgium on July 11-18, 2017. The focus of this Youth Camp will be on carriage driving and draft horse culture. Belgium is known for

its huge draft horses and their capacity for pulling incredible loads. Participants will get a chance to spend a day out on a carriage, see a spectacular demonstration of Belgian draft horses, and maybe even give driving a go themselves.

This Youth Camp will also feature courses on riding and the welfare of the horse by inspirational speakers and teachers. Participants will not only spend time at the GO-internaat (boarding school) in Sint Truiden, they will also pay a visit to a medieval Flemish city. Flanders, which is a part of Belgium, has a rich history that the Belgian Icelandic Horse Association, the "Belgisch Stamboek voor IJslandse Paarden" (BSIJP) would like to share. A visit to an amusement park will also be on the program, as well as many other fun activities. Invitations to register for the 2017 FEIF Youth Camp will be sent out in due time; if you are interested, please contact the USIHC Youth Committee (youth@icelandics.org) for more information.

NEW YOUTH SEAT

The FEIF Youth Committee has created a new seat for young people to join its work on youth-related initiatives. This place is reserved for young people between the ages of 20-28, and the elected person will have the same rights as all other committee members.



YOUNG LEADERS EVENT

The first ever FEIF Young Leaders event was held in Sweden on October 28-30, 2016. Twenty-three young people from Austria, Belgium, Germany, Denmark, Iceland, Luxembourg, The Netherlands, Norway, and Sweden came together for this weekend seminar, which took place in Wenngarn, a thousand-year old castle near Stockholm that has been transformed into a conference and event center. Friday evening started with a team-building exercise during which the participants cooked tacos together. The raw ingredients were provided, but the rest of the preparation was left to the participants, who worked in self-organized teams. Besides cooking, one of the challenges was to set the table (and to find enough seating). All in all, this worked well, resulting in lots of laughter dosed with a little frustration and mellowed with some ingenuity, not to mention a fun and very tasty meal.

Saturday began with a presentation by Ulrika Backan from Wangan University, a college offering courses and a degree in equestrian sciences, including a special program on riding Icelandic horses. We learned that not only does Sweden have a college quite similar to Hólar in Iceland, but Sweden's FEIF representative, Svenska Islandshästförbundet (SIF), has been offering leadership training for young people at various levels for a number of

years now. That was quite an eye opener for all.

After lunch, Olle Larson, the builder and entrepreneur who conceived the idea for the Wenngarn conference center, guided us through his social project, which, in short, turned a disused penal institution for alcoholics and other social outsiders into a thriving village with a mixture of about 300 traditional and modern houses, a bakery, a brewery and distillery, a small school, a gym, a large hall, various cafes, and more. At the center is the ancient castle, which forms the heart of the park and of the social fabric of the village. The tour was interesting and, after the morning's lecture, it was very good to stretch our legs and to enjoy a beautiful autumn day. But most importantly, meeting a successful and relatively modest man, who had a vision and followed his dream to create this model village, building on the past and for the future, was inspirational and struck at the core of our topic.

In the afternoon Karen Woodrow, a level 3 trainer from Iceland, held a very stimulating and entertaining workshop. Karen recently completed a Master's thesis at the University of Iceland on the topic, "What can the project leader learn from horse trainers?" The fact that for her thesis she had interviewed and used the responses of well-known Icelandic horse trainers Sigurbjörn ("Diddi") Barðarson, Mette Mannseth, Þórarinn (Tóti) Ey-mundsson, and Benedikt (Benni) Líndal knitted together the leadership topic with our passion for the Icelandic horse. A few hands-on group exercises invited all participants to reflect on their own strengths and weaknesses, as well as accommodating those of others.

On Sunday morning, adventurer and TV host Musse Hasselval introduced us to his greatest passion: Ruffie, a sort of Europeanized martial art. The whole group engaged in a few exercises, which would later lead to wrestling. The interesting part was that most of these had to be done in pairs, and participants soon had to measure their strength and agility against a friend. Needless to say, most of us ended in helpless laughter. Musse then



went on to share some adventures of his life, not least riding in the Mongolian Derby, and his thoughts and experiences on what feeds motivation and drive in an individual.

After this rollercoaster ride with a charismatic and very honest, exceptional man, we finished the seminar with a presentation by Icelandic horse world champion and Feather Prize winner Thorvaldur Árnason, who quietly demonstrated how his scientific background serves in the optimal training of the human sprinter, as well as the pace horse, of course. Among other things he spoke about how to avoid the build-up of lactic acid in the muscles. (Unfortunately his measured advice came too late for most of the participants, who were sore all over after the morning's exercises.)

By way of feedback, it was clear that there is a demand for this type of event. All were keen to come back, and some asked if participation could lead to a certificate. All in all, the event created great learning experiences, and the participants wish to thank Jannike Bergkvist who pulled it all together.

REGIONAL CLUB UPDATES

There are 12 Regional Clubs affiliated with the U.S. Icelandic Horse Congress. To find the one nearest you, see the USIHC website at <http://www.icelandics.org/regionalclubs.php>. Contact information for each club can also be found there. The following clubs filed updates on their activities this quarter.

ALASKA

BY JANET MULDER

Riders in Alaska have been battling the snow and cold since October to continue to ride. Many members are participating in the FEIF "Out to Oirschot" Virtual Ride by logging kilometers and sharing adventures through Facebook (for more information on the Virtual Ride, see <https://www.feif.org/LeisureRiding/VirtualRide.aspx>). Our Alaska Icelandic Horse Association youth members, known as Tölt Alaska, had a very successful summer and fall, with clinics, group trail rides, crafting for fund raising, and learning about our great breed. The year end was celebrated with a holiday party at Arctic Arrow Farm in Wasilla, AK, complete with sleigh rides.



Trainer Nicole Kempf and Dalur frá Haleggsstöðum at Montaire, where Nicole led a clinic for the FIRC club. Photo by Valerie Durbon.



Members of the Alaska Regional Club on a sleigh ride (left to right): Beverly Short, Denise Chythlook, Ella Chythlook, Haley Wehrheim, Grant Chythlook, Mia Mulder, Brooke Wehrheim, Janet Mulder, Robyn Schmutz, Shay Harvey, Karli Schmutz, and Jane Wehrheim.

FIRC (MID-ATLANTIC)

BY RICH MOORE

In the fall of 2016, members of the Frida Icelandic Riding Club organized a trail ride in Maryland, near the border with Pennsylvania, and attended a riding clinic with Nicole Kempf at Antje Freygang's magnificent new Icelandic facility, Montaire, near Middleburg, VA. Millie Angelino and Diane Hatcher from Pennsylvania have become members of our board of directors. Rich Moore did not seek reelection and stepped down from the board after many years of service. The 2017 Board of Directors of the FIRC will be Millie Angelino, Sverrir Bjartmarz, Antje Freygang, Diane Hatcher, Pat Moore, and Curt Pierce.

Laura Colicchio reports: "Seven FIRC and TROT (a local horse club) riders embarked on an annual trail ride that I organized on November 6. Two of the TROT riders that accompanied us were mounted park rangers in this region. The ride was on a stunningly beautiful trail in the Gunpowder State Park, along the Gunpowder River; it began in Hunt Valley, MD and ended past the Pennsylvania state line.

"This trail was formerly known as the Northern Central Railroad (NCR) Trail

and is now the Torrey C. Brown Trail. What makes it unique is the amazing scenery along the way, including immense rock walls, stately oak and pine trees, and the views of the river adjacent to the trail. There are many opportunities for horses to enter the river as well. The straight, level, hard-packed finely crushed stone trail afford horse and rider good töltng opportunities for long stretches at a time. It is hard to believe that such a rural and bucolic trail exists just an hour north of Baltimore.

"The ride this year was on a particularly lovely fall day. Riders met in a parking lot in Freeland, MD and rode for approximately three hours. There were nice long stretches of tölt and trot, with some canter and walk mixed in. Several great blue herons were spotted along the way, flying above the river. A few of us took our horses into the river to get a drink. My horse, Raven, made a huge splash as he vigorously pounded the water with his hoof, although swimming was not an option in my Xenophon Icelandic saddle! We drew an audience on the stone bridge above us, with people snapping photos of the horses and riders. It was fun and drew smiles all around.

"Afterwards, I arranged for a group luncheon at the Silver Springs Saloon



Pat Carballo riding Dahla from Norris Farm gets advice from trainer Nicole Kempf on the track at Montaire, with a view of the new gazebo in the background. Photo by Al Carballo.



Antje Freygang (above and top right) on Vaskur frá Kagarðarhóli at the FIRC clinic with Nicole Kempf. Photo by Valerie Durbon.

in Cockeysville, MD. Tired and hungry riders had a nice meal and the opportunity to socialize with one another in this quaint rustic restaurant. A ride on this popular trail will be scheduled again in the summer.”

Pat Carballo reports: “Middleburg, VA was the scene of another wonderful clinic organized by Suzi McGraw and hosted by Antje Freygang at her lovely, spacious farm, Montaire, during the first weekend in December. Back by popular demand, the clinician was Nicole Kempf, who traveled from Germany to share her expertise. Also on hand was Terral Hill, from Taktur Icelandic Horses in Kentucky, to provide farrier service. Equine photographer Valerie Durbon showcased her talents by capturing many of the distinct movements and moods of our special breed. FIRC members Patricia Carballo, Antje Freygang, Carrie Laurentot, Tammy Martin, and Bob Shoemaker enjoyed private and semi-private lessons with Nicole. Her focus was on precision moves: seat, legs, and hands. She individualized instruction for each horse and rider pair. As always, Nicole thoughtfully

listened to the rider, observed his or her riding, then provided keen insight by giving each rider specific skills for further work. After focusing on rein work and limbering up in the covered arena, some pairs worked on transitions around the oval track. The chilly December air stimulated the horses to stretch and bend.

“After the day’s work, the group enjoyed a wine-tasting experience at a nearby vineyard; the Loudoun County area is rich in scenic vistas, cozy country inns, and vineyards—did I mention vineyards? Non-riding spouses and friends are always welcome at Montaire clinics. A lovely gazebo overlooking the oval track is just the right spot to relax and watch the horses and riders work out. A stroll around the sprawling grounds is a great way to unwind and soak up the peaceful atmosphere that exudes from this lovely equestrian home. For the horse enthusiast, the quaint nearby towns of Middleburg and Purcellville boast tack and consignment shops. Look for news of more clinics to be held at beautiful Montaire in 2017.”



The CIA Open Fall Sanctioned Show was held October 22-23 at Flying C Ranch in Santa Ynez, CA, with 28 horse-rider combinations. The judge was Nicolai Thye. The highest scores went to Ásta Covert and Dynjandi frá Dalvík in the Tölt T1 preliminaries (8.20) and V1 Four Gait finals (7.80); the pair are shown at top left. At top right are the V1 Four Gait finalists, Ásta and Dynjandi, Heidi Benson and Brynjar from Dalalif, and Christina Granados and Hroftur from Hobby Horse. In the second row, at left are Barbara Chilton riding Harpa from Rock Ranch and Ásta riding Hvati frá Ketilsstöðum in the Pleasure Tölt T8 final. That competition was won by Laura Benson riding Stjarni frá Blönduósi (shown at right) with score of a 7.00. Row three (left) shows another scene from the V1 Four Gait finals, with Heidi and Brynjar. All photos by Will Covert. Below is our littlest competitor, Bella Covert, riding Þór frá Litlu-Sandvík in the lead line class and getting comments from the judge. Photos of Bella by Kelly Blough.

HESTAFOLK (NORTHWEST WASHINGTON)

BY LISA MCKEEN & KATHY LOCKERBIE

The Hestafolk Icelandic Horse Club had a slow drift into deep winter. On October 14-16, Freya Sturm came to Kathy Lockerbie's Silvercreek Icelandic Horse Farm in Bellingham, WA and gave lessons, held a clinic, and continued onto Monday to work with members. It was enlightening and joyous to get together. We are grateful for the support from USIHC to make this clinic happen. It helped us to start a checking account, set up expectations for clinics, and learn on individual levels what next steps we want to take in order to better serve and care for our horses.

Our Freya Sturm clinic was held despite warnings for the worst rain and wind storm to pass over the area in years. We had room for auditors and kept the event open to the public free of charge so that local people could meet the horses and the people who care for them. All in all, five people new to Icelandics attended, 10 riders took part, and another eight were there off and on. It was a great weekend and we plan to have Freya back. For more on the clinic, see Lisa's report below.

Five Hestafolk members attended the



Logn from Extreme Farms, ridden by German trainer Maike Sommer at Red Feather Farm. Photo by Logn's owner, Hestafolk member Linda Wallitner.



Last winter's bitter weather didn't faze these Icelandic mares, owned by Hestafolk member Lisa McKeen: Shown are Flikka and Elska from Extreme Farms and Salina from Evans Farm. Photo by Lisa McKeen.

Guðmar Pétursson clinic at Red Feather Icelandics on October 29-30. It is such a treat to go to Red Feather and enjoy the company of old friends, meet new ones, and learn from a top-notch trainer. The common theme seems to be slower is faster and manage the basics first!

As a club, we continue to refine and redefine ourselves and our goals. We have taken a vote, and from now on helmets are a requirement on all club rides for all riders. We are also assessing our capacity for supporting clinics and a show in the future. We do most of our communication through Survey Monkey, email, and a private club Facebook page. In an effort to support even more Icelandic riders, we started up an open Facebook page for Pacific North West Icelandic enthusiasts. This page is a place for several clubs and for individuals who are not affiliated with a club to find events and to communicate. We had a small get-together in November at Silvercreek as well. Three new members came, our Canadian friends made it down, and we talked, shared learning, and let the new folks try out different horses and saddles. Other club events had to be cancelled because of a cold snap, with wind and ice, but we are excited to meet in January to plan for events in 2017.

Lisa McKeen reports: "What happens at a Freya Sturm clinic? Let me introduce you to Freya's Riding School and give you some examples of how a club clinic worked. First the bio! Freya Sturm was born in Germany in 1985 and is an IPZV Trainer C (licensed by the German Icelandic Horse Association IPZV). She has been professionally training and instructing in Germany since 2004 and training and instructing in the U.S. since 2012; since 2015 she has lived in the U.S. An experienced trainer, instructor, and clinician, she has been self-employed since 2016 with Freya's Riding School, where all breeds and riding styles are welcome. She also has an M.Sc. in Agricultural Economics and is a coach for Coaching with Horses (licensed by Horsesense, Germany), both of which turned out to be important for this clinic. We first met Freya at Red Feather Icelandics, training for them at the time. She now lives in Stevenson, WA



Willa Herndon-Schepper practices with Elsa from Extreme Farm, while clinician Freya Sturm works with Linda Walitner and her gelding Léttir. Photo by Lisa McKeen.

and is traveling to farms and clubs in the Pacific Northwest region, though I'm sure she would travel farther. Freya thinks it is probably more cost-efficient for a trainer to travel to a group in a central location, rather than to have multiple trailers and horses traveling to a trainer. The goal for the Hestafolk clinic was to bring a trainer to a place both riders and horses were familiar with.

"Freya's first task at our clinic was to assess the horses and riders who attended. She gave private lessons on Friday to about 75 percent of our riders. The next day, Freya matched riders and horses with others working on similar skills. The advantage of having two riders in the arena at the same time is that, after having your one-on-one instruction, you have time to practice in the arena while Freya works with the other person. In my experience, this helped me (Lisa McKeen) to make a change, get immediate feedback and feel the difference immediately so that when I work on my own, I know what to feel for.

"Each day we sat together after lunch (potluck and wonderful; we do food well!) for an hour or two, discussing a broad variety of topics driven by the questions of the attendees. We discussed horsekeeping, including feed, socialization needs, riding aids and tools, and the Icelandic horse in general. We learned about the Icelandic horse in Germany and horsekeeping differences around the world. Throughout the weekend, people

and horses got individualized coaching and left relaxed and able to support their horses in learning to work together in a relaxed state. Freya stayed over a day and gave more private lessons for those who wanted to have a bit more time with her.

"Experienced clinic attendees say they got a better understanding of how to work with their horses through the use of aids and seat. Every person worked on how to help their horses transition better and stay relaxed. This relaxed philosophy of training fits well with what I've learned as a teacher of humans. Learning requires risk-taking and a certain calm engagement for the brain to be open to

gather and organize new information. Horses learn best when they are calm and unstressed. So do humans! Each learner in a classroom begins with where he or she is mentally and physically, then works toward attaining a skill set. Risk-taking and mistake-making are requirements for learning. As a classroom teacher with human students, I know that high quality learning depends on my understanding of where each student is, what the learning goal is, and what the steps are to that goal. In a clinic with horses and riders (or handlers in some cases), the clinician has to be able to analyze the horse and the rider. Using this information, the clinician must determine what is the logical progression for that horse and rider. When a person hasn't been exposed to watching hours of riders and horses, specifically Icelandics, it is difficult, if not impossible, to know where the horse and rider team are in the progression of skill. A good teacher/coach can help you to move forward in your learning and your horse's too.

"If you talked to every person who participated in our clinic with Freya, you would hear the same number of take-aways learned. A good clinician, like a good teacher, has the ability to meet learners where they are and support them as they move forward. And keep in mind, Freya is doing that for two learners: the



At the Hestafolk clinic with Freya Sturm, Jo Black works with Perla from Extreme Farm as Freya coaches. Photo by Lisa McKeen.

horse and the rider. Members learned about the benefits of specific bits, bridles, and saddles. We learned about exercises and groundwork. We practiced together so that we could help one another in the future. We can all hope for a healthy community to support the Icelandic horse in America, and learning together can build that community.

“The importance of attending a good clinic cannot be overstated. Many owners new to Icelandics have never had riding lessons or instruction. We learned to ride by getting on a horse, falling off, and getting back on. We learned on trails, not in arenas, and we used the horse that no one would ride, devising our own ways to communicate and get what we want from a horse. Add to that the fact that many of us have ridden Western all these years. Learning about gaited horses is also new to many of us, not to mention learning about temperament, tack, and horsekeeping. People who are open to this fantastic breed are also open to learning. The success of the Icelandic horse in America requires breeders, trainers, and owners to be open to learning new and better ways of doing things. Owning Icelandics is all about learning!”

“I would highly recommend that

you contact Freya Sturm and host a clinic with your club. One benefit of belonging to USIHC as a Regional Club is the \$500 seed money we used to keep the clinic affordable. The introduction was enough to help all attendees understand the benefits of hiring a coach and becoming coachable. We are learning together, and that builds our community and supports our horses. We are looking forward to our next session with Freya! Freya can be contacted by phone at 360-601-9656 or by email at freya.sturm@yahoo.com.”

KLETTAFJALLA (ROCKY MOUNTAINS)

*BY JULIA ANDERSON & KRISTA
BEHRINGER*

Klettafjalla hosted a late fall clinic featuring Ólafur Andri Guðmundsson, who came from Iceland to Boulder, CO. Ólafur Andri was born in Iceland and grew up with Icelandic horses. He graduated from Hólar as a riding instructor and trainer in 2009, and has since been professionally training and instructing in Iceland and in Europe. He runs one of the biggest horse breeding farms in Iceland: FET (fet.is) with great results.

Our clinic was held at the world-class

Lookout Ridge Farms, where we felt very welcomed. Klettafjalla IHC spans Montana to New Mexico, and although not all five states were represented at the clinic, we did have participants who traveled quite far. As always, it was a great re-union and a great opportunity to meet other members we hadn't crossed paths with before.

Ólafur Andri put on a wonderful clinic where we all had the chance to watch him ride our horses to evaluate them or to demonstrate good communication, to help us with anything that may not be going so smoothly, and to help us practice the exercises that he uses on all of the horses he trains.

Julia Anderson reports: “To shine a spotlight on one of our members, we would love to share with you our Rocky Mountain Treasure, artist Chris Pennington. Many of our club members have her beautiful artwork and horse portraits gracing our walls. Chris has always loved horses, and was apprenticed by Candy, the working ranch horse, on her grandfather's farm. She did pony club camp and rode with the local riding club, practicing bareback, Western, and English styles on Mac, her Welsh-Thoroughbred cross. He was her muse/instructor, but when she grew up she didn't have the time or a place for a horse: She was working and raising her children. Later, her mother introduced her to Icelandics; she was inspired by Borkur, the only horse that was on the ground every day for the Great American Horse Race in 1976, never lame or sick. Now Chris lives with her husband, two Icelandics, two cats, a dog, and eight old chickens in the beautiful high desert and artistic culture of New Mexico. In November, she had her first solo art show in Santa Fe, and I was lucky enough to attend.

“People say artists are born, and Chris's story supports that theory. From her earliest years, she was fascinated by her surroundings, the colors and shapes and textures she found in nature. When she was old enough to hold a crayon, she began translating what she saw into images that delighted and amazed the people who saw them. She has a very painterly style that is bold and powerful in color



A happy Chris Pennington of the Klettafjalla Club practices beer tölt with her horse Lukka at a clinic with Ulla Hudson—not as we incorrectly captioned this photo in our last issue. Photo by Sophia Rinderknecht.



Trainer Ólafur Andri Guðmundsson from Iceland gave a clinic for the Klettafjalla Club at Lookout Ridge Farms in Boulder, CO. Here he tries out Skjóni from Maryland Icelandic Horse Farm. Photo by owner Leia Tilton.

and movement. She has genius creating depth and vibrancy in much the style of Van Gogh. Through color, texture, and form, she stylistically interprets the world she experiences and then shares that insight. A true artist, she brings inspiration and appreciation to our community.

“A lifelong passionate student of art, Chris has a wealth of experience in portraiture, landscape art, and commercial design. She says nature is her muse. Formally educated in classical fine arts, with a BFA in graphic design, she continues her informal study through travel, experimentation, and collaboration. She creates graphic designs for a T-shirt shop that has blessed many horse events and clinics with unique equine art. You can contact her by phone at 505-615-2268 or email at Chris@xltshirt.com, and see more of her work at www.chrispenningtongallery.com.”



“Rolling Paint” by artist Chris Pennington of the Klettafjalla Club.



Group photo from the Klettafjalla clinic with Ólafur Andri Guðmundsson. Photo by Iris Heidberg.

KRAFTUR (NORTHERN CALIFORNIA)

BY CAROL TOLBERT

As we enter the New Year, Kraftur members look toward to the future with the anticipation of new events and reminisce fondly of memories made in the past. We welcome new club Board members and congratulate and thank members who have passed the baton. We welcome the much needed rain and, in the same breath, welcome dry stalls (as they are much easier to muck).

Kraftur experienced a busy year in 2016, participating in regional shows, local trail rides and clinics, and even attending the FEIF Youth Cup in the Netherlands. Our member Ayla Green participated in Landsmót, the national horseshow in Iceland (see the story in Issue Four 2016 of the Quarterly) and started her first year in the equestrian sciences program at Hólar University, Iceland.

It was certainly a fun-filled year for Kraftur members, and we ended it at a similar pace. We closed 2016 with members attending the 30th Annual Los Gatos Holiday Parade. Some Youth members spent the night at the Blough's, a fun,

traditional event for the younger members. The parade day is long, with a lot of preparation and waiting as the horses are one of the last groups in the parade (wonder why?!). It is still a fun, festive event, where we get to showcase our horses in front of a very enthusiastic crowd. By all accounts, including the horses', a great time was had by all.

We typically hold our annual club meeting in November, yet the weather was predicted to be pretty nasty on the day it was to be held. While an alternate site was arranged, most people didn't want to brave the storm. We held nominations and elections and announced the winners of a few awards by way of email instead.

We welcome two new members to



Members of the Kraftur club took part in the 30th Annual Los Gatos Holiday Parade. Elizabeth Roberson is at left, carrying the banner with Katherine Monsef on the right. Riding is Jessica Blough.

the Kraftur Board: Meggin Hendricks and Jean Marie Scott. Both have daughters who ride Icelandic horses at Coast Road Stables in Santa Cruz, CA. They will collaborate with current Board members Bert Bates, Linda Moerer, and Carol Tolbert to plan events for 2017. We thank past Board members Laura Hinson and Annette Coulon for their service this past year. Laura served as Vice President and helped with events and our Facebook page; Annette, one of our founding Kraftur members, served as President. Besides hosting clinics and shows at her own Mountain Icelandic Farm, Annette created our new Perpetual Trophy, awarding riders for time in the saddle throughout the year. The winners of this year's Perpetual Awards are Robynn Smith for trail and Jessica Blough for Show.

NEIHC (NORTHEAST)

BY JESSICA HAYNSWORTH

Winter was slow to get started in the Northeast in 2015, but this season many of our horses have been dashing through the snow since November 2016. As we enjoy brisk, chilly rides and drink hot cocoa and coffee to stay warm, we have many wonderful memories to look back on from the past quarter.

As always, the Kentucky Icelandic Horse Show was a highlight this fall. Hosted by Léttleiki Icelandics in Shelbeyville, KY, the show took place from October 8-9. Several NEIHC members made the long journey with their horses to compete in this exciting competition.

Sister duo Grace and Emma Strauss traveled from Pennsylvania. Both are youth riders, and both competed on mares named Spurning: Grace on her young gray mare, Spurning frá Steinnesi, and Emma on her palomino, Spurning frá Arnarhóli. Both Grace and Emma competed in T8 and V6, as well as Beer Tölt, which Emma won against 10 other riders! Grace won the Green Horse Tölt class and finished third in Green Horse Four Gait, also winning the Feather Prize for light and harmonious riding.

I (Jess Haynsworth) traveled from Warren, VT with my gelding Vigri frá



NEIHC youth members Alicia Flanigan from Maine and Isabelle Maranda from Vermont with their year-end awards after a successful show season: Eastern Regional Champion and Reserve Champion in the Youth 12-and-Up Division. Photo by Nikki-Sue Flanigan.

Vallanesi to compete in T1 and V1. We qualified for the V1 final and finished fifth with our best score to date. Thank you to Curtis Pierce, who offered affordable shipping to and from the Northeast, making this event more accessible to a lot of riders who might otherwise have been unable to attend.

From Waitsfield, VT, Richard Davis competed in F1 (Open Five Gait) and in F2 (Five Gait Group Open) on his mare Ríma frá Þverá, as well as in T1 with his mare Þota frá Syðra-Skörðugili. Richard and Þota finished fifth in the T1 A-final.

Also from Waitsfield, youth rider Isabelle Maranda competed on her new mare, Salvör frá Grafarkoti. Together, they won the T8 class, took second in V6, and also competed in T3.

From Tunbridge, VT, Sigrún Bryn-

jarsdóttir competed in Green Horse Tölt and finished second in Green Horse Four Gait on Ísold from Solheimar. She also competed in V1 on Parker frá Sólheimum, finishing third in the A-Final.

Youth Rider Alicia Flanigan, from Maine, competed in several classes on three separate horses. She rode her new mare, Brá frá Fellskoti, to wins in both T5 and V6, and a second place finish in T8. She rode Máni frá Eskiholti II in F2, Pace Test, and the 100m Pace race, which they won! Alicia also competed on her gelding Funi frá Boulder Ridge in T3, finishing fourth in the A-final, and in T6, which the pair won. She and Funi also competed in V3, finishing second in the final.

Congratulations to all of our Northeast riders who made the long journey to Kentucky!

The Kentucky show also served as the final show in the Eastern Regional Icelandic Horse Championships. A number of Northeast riders won year-end awards in the ERIHC championships, and while there is a longer article about the championships in this issue, we would like to briefly congratulate them here:

In the Youth 12-and-Up Division, all three awards went to Northeast riders: Alicia Flanigan, Isabelle Maranda, and Grace Strausser. In the Intermediate Five Gait division, Charlotte Reilly from Pennsylvania was the Reserve Champion. In the Open Four Gait Division, Caeli Cavanagh and Jess Haynsworth, both from Vermont, took Reserve champion and third place, respectively. In the Green Horse Division, Thokki from Four Winds Farm, owned and ridden by New York resident Leslie Chambers, was Reserve Champion. Ísold from Solheimar finished in third place, owned and ridden by Sigrún Brynjarsdóttir of Vermont. It is worth noting that both Thokki and Ísold were bred, born, and raised in the Northeast! The Fifth place Green horse, Spurning frá Steinnesi, was owned and ridden by Grace Strausser, our Pennsylvania youth rider. Congratulations to all!

In November, we once again enjoyed an exciting Equine Affaire in Springfield, MA. Every year this event provides us with an opportunity to share our breed with the horse world at large, and this year was no exception.

Margot Apple reports: "Once again the usual suspects from the NEIHC put up a booth at Equine Affaire. Kara Noble, Margot Apple, and Kara's sister, Pearl set up on Wednesday afternoon. No one fell off the ladder, the Christmas lights lit, and the horse video TV worked. Meanwhile, the Knights of Iceland gathered in Newfane, VT, through the gracious hospitality of Alice Ryan, where they prepared for their three performances in Fantasia. The Knights included Laura Benson, Heidi Benson, Carrie Brandt, Sigrún Brynjarsdóttir, Vigdís Gunnarsdóttir, Terral Hill, Guðmar Pétursson and Ísólfr Þórisson. Horses for the show were trucked in from Kentucky by Curtis Pierce and from Vermont by Richard Davis. Visitors to



NEIHC youth members Grace and Emma Strausser, on their matching mares, both named Spurning. Grace rides the gray mare, Spurning frá Steinnesi, and Emma rides the palomino, Spurning frá Annarhóli. Emma won the Beer Tölt at the Kentucky Show, while Grace won the Green Horse Tölt, as well as the Feather Prize for light and harmonious riding. Photo by Charlotte Reilly.

the booth were delighted to find that the Knights were riding in Fantasia.

"The booth was well appointed with banners and fine photos of horses with their riders at shows, fun rides, and in visits with TV personalities. The tables were full of farm literature, Icelandic riding tour brochures, and recent copies of the *Quarterly*. A clothesline was hung with Knights of Iceland t-shirts. The display of tack and a riding suit brought in some orders for these items as well. And, as always, the horses who took turns in the stall were a huge attraction. Two new books from Iceland were featured, with their authors available to autograph: *With Horses* by Ísólfr Þórisson and *Horseplay* by Helga Thoroddsen. Both books provide excellent training and riding information, aided by beautiful

photos of Icelandics and their people. The breed demonstration on Saturday was led by Sigrún Brynjarsdóttir, Richard Davis, Isabelle Miranda, and Becky Hoyt. The booth was well tended by faithful volunteers Richard, Kara, Margot, Martina Gates, Nicki Esdorn, the Knights, and Leah Greenberger, who provided two horses to the booth on Sunday. Both new and repeat visitors were happy to find us. We met some who already owned an Icelandic but did not know of the club. Someone, looking to buy a horse, visited the booth on Thursday. They texted Kara on Saturday to say that they had found one they wished to buy at The Vermont Icelandic Horse Farm! Not bad. Many thanks to everyone who helped make this a good year at Equine Affaire."

The USIHC held elections this year,

and NEIHC Board member Jessica Haynsworth was elected to the USIHC Board. Along with Leslie Chambers, there are now two NEIHC Board members who serve on the USIHC Board; both attended the USIHC Annual Meeting in Pittsburgh, PA on January 14.

2017 is shaping up to be an exciting year for the NEIHC. On April 8, we will have our Thorrablót party and annual meeting in Warren, VT, hosted by Mad River Valley Icelandic Horses at the home of Anne Hyde and Bill Haynsworth. Mad River Valley Icelandics will also be hosting a very exciting clinic during this time, along with The Vermont Icelandic Horse Farm in Waitsfield, VT. The clinician is a master horseman, who will be teaching at both locations all day Friday, April 7 and Sunday April 9, as well as on Saturday morning, before Thorrablót begins. Bring your own horse, or lease a horse from The Vermont Icelandic Horse Farm for lessons! Additionally there will be a seminar on horse breeding at 1:30 on Saturday, before the annual meeting begins. Tea and snacks will be served, and this seminar is open to all, regardless of participation in the clinic. Contact Jess Haynsworth for more information at madrivervalleyicelandics@gmail.com.

From April 20-23, a USIHC Sport Judging Seminar will be held at Thor Icelandics in New York. Þorgeir Guðlaugsson

will be the instructor.

It's never too soon to start planning for the NEIHC Open Show, which will be held earlier than usual this year, on June 24-25 at Thor Icelandics in Claverack, NY. Carrie Lyons Brandt of Taktur Icelandics in Kentucky will be teaching a pre-show clinic from June 21-23.

We look forward to warmer weather, and hope to see many of you at these exciting events in 2017! Visit our website at NEIHC.com for more information.

NWIHC (CENTRAL WASHINGTON)

BY LINDA TEMPLETON

There's a new kid on the block: It's the North West Icelandic Horse Club, recently established in central Washington State. This club was formed with the desire to bring more education to our horses and their people. It is our belief that with each bit of education or information we put in our toolkit, the better stewards we are to our horses and the more we will want to learn. We believe that we owe it to our horses to educate ourselves and them, to give them full and robust lives as the grand ancient breed they are, rather than sitting beautifully in our pastures with their potential not being realized. Why have a high performance, multi-use "vehicle" and only drive 25mph in town?

In that interest, the club supports

many of the events at Red Feather Icelandics in Trout Lake, WA. This past October, Red Feather was fortunate enough to host a Guðmar Pétursson Clinic; this clinic was also strongly supported and attended by members of our sister clubs, The Cascade Club and Hestafolk.

There are clinics and then there are clinics; there are trainers and then there are masters. Guðmar is well known, respected, and admired throughout the U.S. Icelandic horse world. He brings years of experience and multiple disciplines together to support his philosophy, as he says, "To me, natural horsemanship focuses on 'teaching' as opposed to 'breaking.' This approaches training from the horse's point of view, and lets the horse have a choice, so that his way is our way."

One of the largest clinics ever held, this one brought Red Feather to capacity with 24 participants, eight of whom were brand new to the Red Feather clinic family and to the USIHC and its regional clubs. It was amazing to see the growth and interest in the Icelandic horse in the Northwest and surrounding states. Riders came from Washington, Oregon, Idaho, Utah, Nevada, and California.

Participants said they were "impressed with the ridden demos Guðmar gave, explaining what and why he was doing it while he was doing it" and praised his "fantastic demo and explanation of running walk."

"Guðmar is exceptional," said another: "I got more out of this clinic than any others."

The NWIHC is in its fledgling stages, so please bear with us while we build our web and Facebook presence. Stay tuned for upcoming educational clinics and workshops that will offer superb opportunities to learn about the Icelandic horse and what this incredible breed is capable of giving us. If you are interested in more information or want to join us, please contact our president, Debby Dillard, at dbydill@gmail.com.



Icelandic trainer Guðmar Pétursson taught a clinic for the North West Icelandic Horse Club in Washington. Here he coaches Chris Cerrito on Odinn. Photo by Linda Templeton.

DRIVING YOUR ICELANDIC

BY NANCY WINES-DEWAN

“Uneducated!” declared the first Icelandic trainer I had ever met. He was referring to Máni, my nine-year-old Icelandic horse, recently imported from Iceland in April 2003. I bought him and brought him to my farm in Maine in August of that year.

Máni had apparently never been lunged, was afraid of the lunge whip (or any whip for that matter), and didn't know how to trot (at least on command). The trainer told me to lunge him, work on his trot, and do ground work. Once he was lunging well and trotting on command, I decided to just keep on going into ground driving and teaching him to pull a cart. He was becoming “educated”! I had taught my first pony (a Shetland cross) and two miniature horses to drive several years earlier, so I got out my driving training books from that era and went to work.

Máni was very sensitive, reactive to anything touching his sides or legs. A driving harness consists of lots of straps that touch a horse all over. A driving horse should be completely nonplussed about it all. So, my first step was to desensitize him to whips, straps, and reins all around his body.

Máni was 10 years old by this time,

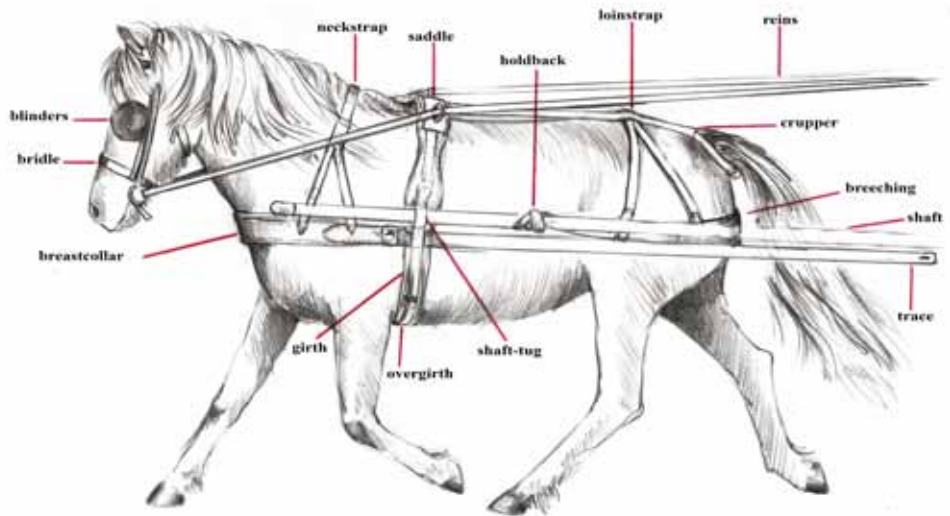

What's in a harness? Lots of straps and buckles, all of which have important and specific functions, and which must be adjusted to fit an individual horse.

perfectly calm around logging trucks, cars, school buses, bikes. I could ride him out on trails alone, or with other horses. However: Don't assume that your calm, riding horse, who never spooks on trails, will be equally as calm pulling a cart. It's safer, actually, to assume that your older horse knows nothing, and start from the beginning.

Beginning ground work is similar for both riding and driving, but there are cer-

tain basic differences in each discipline. Riding tack usually includes a saddle and bridle, but generally nothing around the haunches or flanks of the horse. A driving harness goes in front, around, in back, and even under the tail of the horse, and the bridle usually has blinders which restrict the horse's peripheral vision. If a riding horse spooks or bolts, the rider may or may not stay on—but in neither case is there a “predator” (i.e., the cart) following the horse. If a driving horse spooks, the cart will remain with him (at least at first) and can cause further panic.

STEPS TO THE CART

A full description of the steps I take in training a riding horse to drive is outside the scope of this article, but here is a quick list so you get an idea of what is involved.

1. Stand! This command is probably the most important lesson a driving horse needs to learn.
2. Introduction to the harness.
3. Long lining.
4. Ground driving in the arena, on the road, and wherever the horse might be driving.



Nancy Wines-Dewan and Sinna from Icelandic Magic take to the carriage roads along Lake Champlain, near Shelburne, VT.

5. Verbal aids.
6. Whip aids.
7. Pulling a weight.
8. Introduction to the cart: in front of horse, next to the horse, and behind the horse, both stationary and moving.
9. Place the shafts in the shaft tugs (but don't hitch).
10. Hitch the horse to the cart: You need two assistants plus the driver, who is behind, not in, the cart.
11. Finally, hop in the cart and drive—still with an assistant or two at the horse's head.
12. First solo drive—in an arena or another enclosure, and with an assistant walking next to the horse.

After training several Icelandic horses to drive, here are some things I've learned the hard way:

LESSONS FROM MANI

Rule #1: If, at any point, the horse seems nervous about a new step, back up and work through the issue. Do not assume that the problem will go away by itself. Máni was calm at a walk, but occasionally got agitated at a faster pace. I consulted a trainer who suggested a few exercises, which I did. Máni seemed to be improving, so I kept going.

Rule #2: Never, ever, drive a green horse without an assistant. Even if the horse has been calm and steady umpteen times before, there is always a chance that something could happen. And, with Máni, that's exactly what did happen. He had been calm, hitched to a cart and driving at a walk or trot for at least a month, so I thought it would be safe to drive him down to a neighbor's farm a short distance away by myself. This was not a good idea. He got upset when I asked him to turn for one final circle before heading home, and I got out of the cart—which brings me to:

Rule #3: Abandon the cart only as a last resort. You will have more control over a runaway if you are in the driver's seat than you will trying to catch the horse from the ground. In this case, as I reached Máni's head, he whirled around, flipped the cart, flipped himself, and

scrambled to his feet. I still had the reins, so I tried to unhitch the cart while holding him. That could make another rule: Don't attempt to hitch or unhitch without an assistant standing in front of the horse, holding his bridle (aka, "heading"). I was not completely successful in unhitching the cart, and Máni took off over the fence, leaving the cart behind, and ran home in an utter panic. The cart and his harness took the brunt of the physical damage, but Máni was terrified of both for a long, long time. All I had to do was bring the harness within 10 feet of him and he would panic.

Rule #4: Choose your future driving horse carefully. Some horses are not good candidates for driving. I decided that Máni was one of them. I did re-introduce his harness, and ground drove him after a while, but he was still nervous. He was a great trail horse, and that's what both he and I decided he should be.

LESSONS FROM SINNA

My next experience training an Icelandic horse to drive was a completely different story. Sinna was a yearling filly when she traveled from Washington state to come live with me in Maine. By the time she was four, I had done ground work with her in preparation for introducing both a cart and a rider. However, she was still small, so I decided to concentrate on driving that summer. While ground driving her one time, she put her head down and her bridle slipped right off, landing in a heap

around her feet. She looked at it, stepped calmly out of the tangled leather straps and proceeded to graze on a bit of grass nearby. I knew, at that moment, that I had a good driving horse candidate in her!

In fact, as we proceeded, I discovered that she was calmer in harness than under saddle. This difference continued for several years. She would (and occasionally still does) spook under saddle, but did not have the same issues in harness. Perhaps it's the blinders? Perhaps it's the sense of "enclosure" that the harness provides vs. the saddle? I'm not really sure, but she has always seemed to enjoy driving.

Sinna has been driving now for nine years. We've done sleigh rallies, demos for young children and adults, and long pleasure drives on the 40-plus miles of carriage roads in Acadia National Park in Bar Harbor, Maine. She has seen buses, logging trucks, bicyclists, baby carriages, large carriages driven by horses three times her size—and remained calm throughout. Her biggest issue now is standing still while being hitched away from home. Back to the training board for that one!

LESSONS FROM BRENNA

Brenna was two when she arrived at my farm. She has a totally different personality from either Sinna or Máni. Her normal reaction to scary things is to startle in place rather than to spook. The first time I hitched her to a cart, she started driving as if she had been doing it for months. Finding an assistant to work with me was



Closer to home, Nancy and Sinna enjoy the country roads near their home in Maine. Photo by Deb Plengey.

not always possible, so I began to ride her first. Brenna had to be introduced to traffic (which, along with large boulders, were the two things that would make her take off) and other distractions she would find driving around. I've learned that if I introduce a new stimulus, or a new lesson, and then let her process the experience for a day or two, she will work her way through it.

However, you never know when something unexpected may happen. After she had been driving for several months, I brought her into my arena to hitch her, and she became very agitated. All of a sudden, she reared and came down with one of the shafts of the cart underneath her elbow. It took two of us several minutes to extricate her and release the cart. To her credit, despite being obviously nervous, she stood absolutely still during the process. (More proof that she would make a good driving horse.) That summer and fall we went on numerous trail rides, both alone and with other horses, adding to her "life experiences," which will help her driving as well as riding.

Rule # 5: When a situation presents itself as a problem, work through it and back

Metal Easy Entry Cart (front entry)

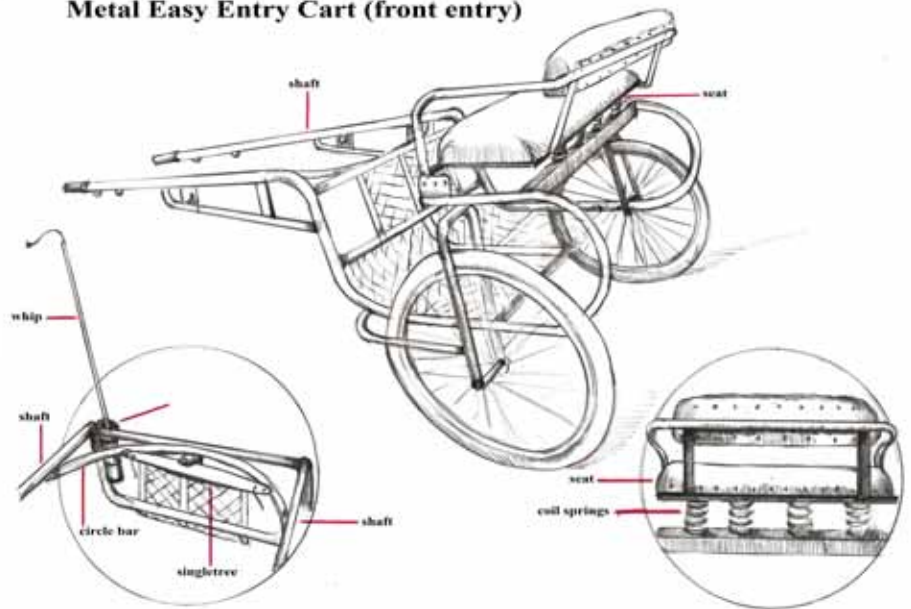

up. This rule is similar to Rule #1, but not exactly the same. After Brenna got the cart shaft caught under her elbow, I made sure that she was not nervous about the cart. Apparently, she was not. She did not seem the least concerned whether the cart followed her, or was pulled next to her, or was pulled in front of her: She actually liked following the cart, sniffing it,

etc. I made sure that she was not nervous about the harness: no reaction there. So I went back to harnessing and hitching her in the barn, slowly, in increments, and she was perfectly calm. Next we ventured back into the arena, while still hitching in the barn. My suspicion, based on her calm reactions to everything else, is that she is very sensitive to flies, so by staying inside to hitch, we avoided the problem. Once she was working, flies didn't seem to be an issue. That winter, we took a necessary break from driving, but continued to do ground work.

Wooden Wheel Road Cart (rear entry)

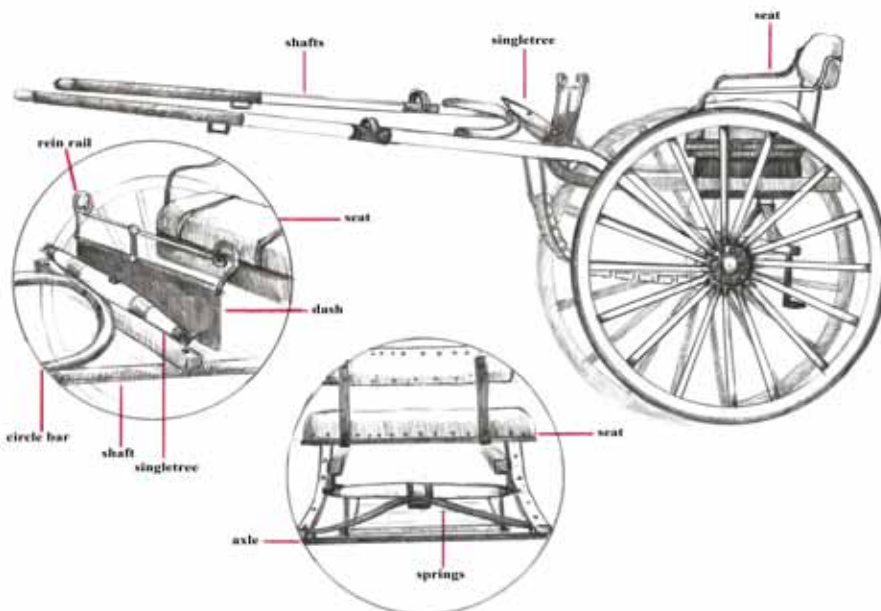

A training cart is a two-wheeled, easy entry or "breaking cart." It must be sturdy, balanced, and stable; it must be in good condition and safe; and it must fit the horse. Find an experienced driver to check the fit of any cart you consider. Carts and horses vary widely in their measurements. The broad categories of "mini," "pony," "cob," and "horse" mean different things to different people. Measurements are a much better indication of a cart which might fit your horse. Refer to the American Driving Society's chart for guidelines.

Rule # 6: What works well at home doesn't always go as well away from home. I discovered this truth when I brought Sinna and Máni to Acadia National Park for the first time six years ago. Sinna had been driving for several years by that time, and I had not had any trouble hitching or driving her either at home or elsewhere. What I didn't anticipate was her reaction to leaving her buddy, Máni, at an unfamiliar barn while I attempted to hitch her and drive away. I have trailered Sinna to many pleasure drives and had not seen her react in that way, but I realized that I had never trailered her with another horse and then taken her driving alone. Obviously, I had discovered a gap in her training and had more work to do to close that gap.

Rule # 7: Imagine the worst, and prepare for it! On a beautiful autumn day, I was driving Brenna out to my back field, a

route I had driven her a number of times before. She had been perfectly calm, walking and trotting around the field, and we were headed back to the barn. As we came out of the woods on our farm road, she began to pick up speed. What I did not see is that, in the pasture nearby, a horse had started to run. Brenna probably didn't see him either, but she heard him. She ignored my aids and increased her speed. When she made a turn to the barn, I quickly decided that this was the better of two options, the other possibility was the road with late afternoon traffic. Brenna stopped at the end of the barn aisle and remained still while I unhitched her. She did not exhibit any physical or mental signs of trauma. In the days following, I reconstructed the incident and second-guessed myself multiple times. I remembered a few experienced drivers talking about driving in a fenced area: They said they would much rather drive in an unenclosed arena, because they felt it was safer to have more space in which to initiate a circle to slow their horse down, without overturning the cart or running into walls or fenceposts. I began to see the wisdom of this.

DRIVING ADVENTURES

The Maine Driving Club, our local carriage-driving association, has been invaluable to me, providing resources, advice, activities, mentors, and great stories. One of the founding members, now in her 90s and no longer actively driving, owns a metal training cart, which she graciously loans to anyone who needs it. This is the cart I used to train all four Icelandics in my barn. Ursula's red cart has been passed around the driving community for many years, and has survived countless horses. The metal frame has undergone several "re-shapings," all of which have been easily repaired by our local machine shop.

Although I can take short drives around my own farm, what my horses and I really enjoy is going out with other horses and drivers. The Maine Driving Club has sponsored pleasure drives, and some members have graciously opened their farms and trails to us. Many drivers take advantage of the beautiful carriage roads at Acadia National Park at least once during the season. This year I took Brenna for her third trip there, though



Here Nancy drives Brenna from Ice Follies in the Maine Driving Club's Driving Derby in Cape Elizabeth, ME. Photo by Schooner Hill Photography.

it was only her first time being hitched at all. We drove around the stables and campsites, but I didn't feel she was quite up to the challenge of driving her on the carriage roads. By riding her there, I was acclimating her to bikers, large commercial carriages, people hiking with dogs, and other distractions that she would encounter when we finally drive.

When the winter snows arrive, there are sleigh rallies. The Skyline Farm Carriage Museum, which is a short distance from my farm, hosts several events during the year, including a sleigh day, and carriage driving demonstrations for community organizations. Both Sinna and Brenna are frequent participants in these events.

This past summer we ventured into low-key, low-stress competitions called Driving Derbies. A Driving Derby is akin to a dog agility trial, only with a cart and horse rather than a dog. The course may include pairs of cones or obstacles with lettered "gates," or both. Each of these must be driven in the proper order, and in the proper direction, according to a map the competitors receive when they arrive at the site. You are allowed to walk the course(s), without your horse, before the show starts to plan your strategy and to figure out where you need to drive. These are timed events, with penalties for hitting the cones or driving off the course. Most horses love this sport as much as their drivers do!

This season, we participated in three derbies. At the first one, Brenna was as calm as could be—until she had to wait her turn before running the obstacle course, in the heat, with bugs flying around. Up she went, rearing in protest. The second derby was in cooler weather, with a lovely brisk breeze along the ocean, and Brenna loved it. The third derby threw us a few curves: This event included an optional dressage test. The dressage ring was "fenced" with white electrical tape, which fluttered (audibly as well as visually) in the wind. Brenna was totally spooked and threw in some swerves that were definitely not part of the dressage test pattern! The cones course was fun—no problems there—but while we were waiting our turn at the obstacle course, she spied a photographer kneeling down, looking like a predator waiting to strike. She spooked, tried to bolt, and, yes, once again, reared. Judging by the comments from other drivers, hers was not an unusual reaction to a crouching person with a camera.

Brenna, who has been driving for three years, is still considered to be at a "training" level in both dressage and derbies. At each of the derbies this year, she placed second or third in her division. Because carriage drivers in this area are not accustomed to seeing an Icelandic horse driving, she attracts quite a bit of attention at these events.

AN ALMOST FREE HORSE

BY LIZ STIMMLER

Free horses, like unicorns, are mythical creatures. So when a friend contacted me about an “almost free” Icelandic horse, I was understandably skeptical. At the time I owned an 18-year-old Paint gelding, retired due to stifle issues. I said for years that my next horse would be an Icelandic and had begun saving for a nicely started young one. Since my budget doesn’t usually stretch to cover board for more than one horse, the plan was to keep my Paint as long as he was getting around okay and then, after making that final hard decision, start shopping for my Icelandic. I figured I would have a few years before this happened. Luckily, I still rode quite a bit due to my great group of friends who trust me with their horses.

My friend provided further details about this “almost free” horse: She was



Fergi's Icelandic name, “Fegurdar Brunka,” could be translated as “Black Beauty.”



“Green broke” at age 10, Fergi needed to be restarted. Here Liz and a friend work on relaxation and desensitization.

a registered Icelandic (US2006203552) named Fegurdar Brunka from Clear Spring Hollow (but known as “Fergi”), a 10-year-old mare who was supposedly “green broke” with an owner who had a large herd and not enough time. Oh, and the mare had some unfortunate training experiences in her past. Oh, and a history of bucking like a bronc. After hearing this, red flags were waving, and my initial reaction was: “No way!” I did not want to take on a horse with those issues. I wasn’t sure I had the training skills required, and I’ve always preferred geldings. I wanted to wait to buy a young horse without old issues.

I’m still not quite sure how I wound up in a truck with my friends, trailer in tow, to go and “just have a look” at this mare. I made it very clear that it was in no way a sure thing that we would return with a horse in the trailer. At this point I hadn’t even seen a picture of Fergi.

When we got to the farm I was introduced to a large-eyed, sweet-faced, petite,

nice conformed, overweight (with lumpy fat deposits along her ribs!), black mare. I asked to see her move around freely, and was pleasantly surprised to see her pick up a tölt as her first choice of gait. She was extremely skittish about being approached while loose, especially if there was a lead rope in hand, but very curious. So, I concluded, she was good looking (under the fat), at least four-gaited, appeared sound, and was unsure, but still curious, about people. Fergi walked into the trailer like a champ.

CHALLENGES

We agreed that I would take her on an open-ended trial period, with the ability to return her if at any time I felt that things would not work out. Now the challenges began. Knowing about the issues in her past, I knew I would have to start her over at the beginning. I had never started a horse before. Would my horsemanship be good enough to convince this sensitive mare that she could trust me?

My mantra over the next few months

became patience and groundwork. Fergi's reactions told me that she had been overcorrected in the past and was unsure what humans wanted her to do, though she really wanted to give the right answer. She became anxious because she was worried about "getting in trouble" for giving a wrong answer. Every small try needed to be rewarded in order to build her confidence and trust.

The first few weeks we worked on desensitization, groundwork, and learning to lunge. I introduced many things to determine what she already knew, and what she didn't. She would accept a saddle and bridle, but fly spray was evil, and she didn't want to balance when picking up her hind feet. My fix for fly spray was filling a utility spray bottle with water and spraying her every day until it was no longer a problem. Picking up her hind feet was an exercise in building her confidence and balance. Fortunately, my farrier is a fantastic and patient man, and the first visit went very well.

TRUST

I unintentionally triggered the first blow up. I thought it would be nice to lead her around the farm and introduce her to the myriad buildings, farm equipment, other horses, and ... cattle. The buildings, equipment, and other horses were just fine. She did not like the cattle at all. They came up to their fence and, even from more than 20 feet away, Fergi panicked: She tried to both run away and jump into my arms. By the time I had her to a state that I could safely walk her away, I was sure I had set us back to square one, in terms of trusting me, but surprisingly she was back to normal after a day off. We returned to see the cattle with an equine companion who has no fear of them, and it was a much calmer experience.

Once I had a fairly handleable horse, I decided to arrange a pre-purchase exam. I hadn't seen anything that made me think she had any physical issues, but I wanted a clean bill of health before making a final decision on keeping her. The exam went great, and the veterinarian found no physical problems.

I sat on her twice over the next couple of weeks and was led by a friend, at the walk, on a lead rope. There was tension at first, but she eventually relaxed, and I would dismount.

MASSAGE

I continued to do groundwork and desensitization with Fergi, but was becoming troubled by her ongoing tension and reactivity. She just didn't seem to be able to relax. When my friends had an experienced massage therapist come out to the barn to work on their horses, I made sure that Fergi was included in the appointment. This turned out to be the best decision I could have made. The therapist said that in her 25 years of experience, the muscles in Fergi's poll were the tensest she had ever encountered. She made the comment that Fergi "must have a hell of a tension headache."

This explained most of Fergi's reactivity issues and inability to relax. The therapist worked her magic, and the next day I had a different horse. Fergi was able to relax and react to things more as I would expect of a green Icelandic horse.

Subsequent to the massage, I continued with desensitization, groundwork, and lunging and she progressed much more quickly. I scheduled weekly massage sessions to keep the tension from building up again.

MORE IDEAS

A third ride walking on a leadline was fantastic: Fergi was very relaxed. The fourth ride was almost a disaster. I lunged her prior to getting on, and my friend then used the lunge line to lead her. At one point Fergi saw the excess line in my friend's hand at an odd angle and decided it was terrifying. She went sideways and backwards. I almost hit the dirt, but somehow managed to stay aboard without scaring her further. My friend calmed her back down and once she was quiet, I swung off. Then I took a break until the shakes passed.

At that point, I decided to enlist the help of a trainer. I needed assistance with ideas for exercises that would help Fergi overcome her fear of ropes and be more prepared for independent riding. The trainer had a number of great ideas, and we began working on the preliminary steps for ground driving. The rationale was that Fergi would become comfortable with the long lines and listen to me.

As of this writing, I have had a few more quiet rides walking on a lead rope. Fergi is almost over her fear of ropes and she is close to ground driving. I decided to commit fully to this "almost free" sweet mare and signed a bill of sale. Wish us luck!



Liz Stimmler and her "almost free" Icelandic horse, Fegurdar Brunka from Clear Spring Hollow (known as "Fergi"). From tension and challenges, they are advancing to comfort and trust.

WORLDFENGUR 101: PART 2

BY MARTINA GATES

Welcome back to the wonderful world of WorldFengur! Whether you want to breed your horse, buy a horse, learn more about your own horse, or just browse around looking at other people's horses, this international database provides a wealth of information for everyone.

WorldFengur is the studbook of origin for Icelandic horses all over the world. Only purebred Icelandic horses, whose ancestry can be traced back to Iceland, can be registered there. In WorldFengur, you can find comprehensive information on around 450,000 Icelandic horses, including pedigree, offspring, assessments, owners, breeders, BLUP, colors, microchips, virtual mating, and more.

It is not just numbers and data: WorldFengur is a portal into the history of the Icelandic horse, connecting past generations to our horses today. By owning an Icelandic horse, you also own a piece of fascinating history.

Breeding your horse and having it evaluated, with its scores logged into WorldFengur, gives you a glimpse into the capabilities of your horse's ancestors and what they have passed on. You can follow certain traits for generations through evaluation scores, and the addition of BLUP scores further enhances the data.

As a USIHC member, you only need

a web browser and a connection to the Internet to access WorldFengur. All USIHC members get a free 12-month subscription (a value of 129 Euros!), making it one of the biggest perks of USIHC membership—apart from the Quarterly, of course. Once you have activated your subscription, and have a username and password, just go to www.worldfengur.com and log in.

A BRIEF REVIEW

When you first open the WorldFengur home page, you will see that you have access to certain information without logging in, such as news, basic horse information, and results from breeding shows and sport competitions. But for the more detailed information I'm going to discuss in this article, a log-in is required.

Once you have logged in, you will see a menu on the left with many search options. In the last issue of the Quarterly, I introduced you to WorldFengur's basic functions. (See "WorldFengur 101: Part 1" in Issue Four 2016, in our online archive at www.icelandics.org.) Using the stallion Blær frá Torfunesi as our example, we learned several ways to find a specific horse, and some of what WorldFengur can tell us about that horse's pedigree, identification marks, health, breeding record, assessments, BLUP evaluation, offspring, breeding awards, competition results, owners, and even what the horse looks like, through photos and videos.

In this article, we'll play a bit with WorldFengur's more advanced functions, so you can begin to see its importance and make the connection from your horse to its ancestors.

But before we begin, here's a brief review of some basic points to keep in mind:

1. *The correct spelling:* You must use the correct spelling of the horse's name; otherwise the search engine will not find the horse. If you need to type in an Icelandic letter that is not on your keyboard, you can click on the special letters above the form, and the program will fill in that letter for you automatically.

2. *The correct number:* You must use the



- BETTER WF
- DISCLAIMER
- INTRODUCTION
- FRONT PAGE
- LANGUAGE
- PADDOCK
- HORSE
 - Search
 - Advanced search
 - Search for assessments
 - Colour table
 - Virtual mate selection
 - Select stallions
- HORSE NAMES
- PERSON
- BREEDING SHOWS
- LANDSMÓT VIDEOS

original FEIF number that was assigned to the horse at birth. The program will not recognize the Life number assigned to the horse in its new country of residence, i.e. the country into which the horse was imported. The original FEIF number is comprised of five components (see below):

3. *The magic use of the underscore:* When there is data that you do not know or do not wish to include in a search, you can simply use the _ (underscore) as a placeholder. For instance, if you are searching for all stallions born in Canada you would enter CA___1 (4 underscores) into the FEIF ID and the program will find all stallions born in Canada. However, please take care when using this magic symbol! You always have to narrow down the search condition. Otherwise, you might

ACTIVATE YOUR WF MEMBERSHIP

To activate your WorldFengur membership, log in to the USIHC website, www.icelandics.org. Select "Membership" > "World Fengur Access" in the drop-down menu. Follow the instructions on the page. USIHC will verify your membership and send your email address to WorldFengur. Within 24 hours, you will get an email from WorldFengur via the USIHC registry with a link to the WorldFengur sign-up, a pin code, and an activation code. Follow the instructions and presto! You are in the wonderful world of World Fengur! You'll need to reactivate your WF subscription each year after you renew your USIHC membership.

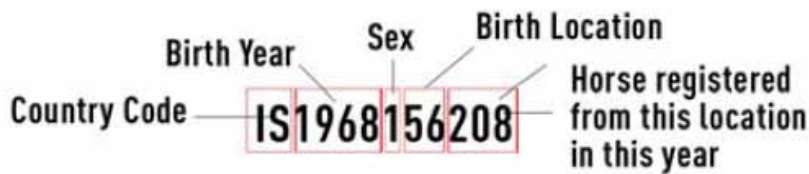

get a list of all the horses registered in WorldFengur!

4. *The prepositions added to farm names:* In February 2009, WorldFengur automatically added the preposition “from” used in the language of each country. The change was made so that the preposition remains unchanged, no matter which language you choose in WorldFengur. Therefore you never type in the preposition, just the first and farm name: US2010104426 Marel from Creekside Farm (US born), IS1991158626 Kormákur frá Flugumýri II (Iceland born), DE1985107964 Gustur vom Wiesenhof (German born).

ASSESSMENT SEARCH

The Icelandic horse is one of few breeds with international evaluation standards, so that breeding horses from all over the world are judged on the same 10 points of conformation and 10 points of ridden abilities. These assessments are all entered into the WorldFengur database. Having access to this information allows you to compare the quality of your breeding stock with Icelandic horses around the world, both past and present.

There are several different ways to search for these assessments. If you select Highest Assessments under the BREEDING SHOWS menu, you can enter the year in which you would like to view all the horses with the highest assessments.

You also have the choice to click on Search for Assessments under the HORSE menu. This will bring up a window with endless search opportunities. For example, you could search by all horses scoring 9.0 for pace. Or you could see all the assessments a specific horse has received. Or all the horses scoring a certain score at a specific breeding show. Maybe you would like to know how many offspring of a sire have scored 8.0 or higher for tölt.

Just for fun, try this: Let’s find out how many first-prize horses there are in

the U.S. Under the HORSE menu select Search for Assessments: This will bring up a search window. Select “United States” as the Country of current location. Then, next to TOTAL (under the assessment section), fill in the score 8.0 and, next to it, 10.0 (just to cover all horses).

Click Search, and a new page will pop up showing every horse in the U.S. with assessments over 8.0 (which qualifies as first-prize). If you click on View, at the end of each row after a horse’s total score, it will bring up that individual horse’s assessment sheet, which you can choose to print. If you click on the header on the search result page, you can re-organize the data. In our example (which is not complete, and is a little out of date), the data is organized by the age of the horse.

Or maybe you want to find all the

Number: 61.

FEIF ID	Name	Name of the farm (studname)	Colour code	Country of current location	Breeding shows	Year of the show	Judged in	Rider	Eigandi	Conformation	Rideability	Total	View
DE1982107970	Tjebur	Linderhof	2500	US	California	2002	US	All Gudmundsson	Aika Bredtve	7.95	8.07	8.02	View
DE1995202323	Fjalda	Wiesenhof	1800	US	Cascade Icelandic Horse Club Evaluations	2006	US	All Gudmundsson	Vera Massimo	7.88	8.17	8.08	View
DE2005134115	Bjartur	Hof Osterkamp	8600	DE	Creekside Farm Spring Evaluation	2010	US	Frauke Schenzel	Alexander Wulfsen	8.11	8.11	8.11	View
IS1900188754	Hökur	Stam-Bæ	1800	US	Tulsa Oklahoma Evaluations	2000	US	Svein Leifsson	M Bedinger Or J Bedinger	8.18	7.89	8.01	View
IS1981138081	Indetur	Inni-Skejabrekk	2500	US	Tulsa Oklahoma Evaluations	2000	US	Guðmar Þór Þórunsson	Guðmar Þór Þórunsson, Letteki Icelandic LLC	8.18	8.47	8.38	View
IS1981138081	Indetur	Inni-Skejabrekk	2500	US	Flugur Evaluation	2004	US	Guðmar Þór Þórunsson	Guðmar Þór Þórunsson, Letteki Icelandic LLC	8.22	8.57	8.43	View
IS1981284514	Heying	Syðri Úthátubum	1750	US	Flugur Evaluation	2004	US	Guðmar Þór Þórunsson	Karen Barr Duffy	8.59	7.71	8.06	View
IS1982107980	Gleær	Hásey	3510	US	Flugur Evaluation	2004	US	Guðmar Þór Þórunsson	Bonnie Windell	7.81	8.19	8.04	View
IS1982237931	Von	Mýrsl 2	1200	US	Flugur Evaluation	2004	US	Stalln Agústsson	Ranee Melton Smith	7.85	8.1	8	View
IS1982205288	Rák	Akureyri	1530	US	California	2002	US	All Gudmundsson	Anne-Marie Martin	8.15	8.55	8.39	View
IS1984188027	Þór	Fréttabækka	7200	US	Cascade Icelandic Horse Club Evaluations	2006	US	All Gudmundsson	Willy and/or Eileen Ma	8.28	8.05	8.13	View
IS1984257095	Vordis	Sauðférróki	1500	US	Northampton, Massachusetts	2003	US	Baldvin Ar Guðaugsson	Shannon Fitzgerald	8.08	8.41	8.28	View
IS1984257041	Þikka	Aal 1	2500	US	Tulsa Oklahoma Evaluations	2000	US	Baldvin Ar Guðaugsson	Creekside Farm Rutledge LLC	7.83	8.18	8.04	View
IS1984258003	Heying	Flugumýri	2500	US	Flugur Evaluation	2004	US	Guðmar Þór Þórunsson	Pamela Ann Merlo	7.90	8.02	8.36	View
IS1984258003	Heying	Flugumýri	2500	US	Northampton, Massachusetts	2003	US	Guðmar Þór Þórunsson	Pamela Ann Merlo	8.04	8.54	8.34	View
IS1984258008	Þikka	Flugumýri	3400	US	Flugur Evaluation	2004	US	Guðmar Þór Þórunsson	Bonnie Windell	8.11	8.17	8.15	View

How many first-prize horses are there in the U.S.? Sixty-nine, according to WorldFengur’s “Search for Assessments” tool. Here are a few of them.

Search for assessments

Number: 6.

FEIF ID	Name	Name of the farm (studname)	Colour code	Country of current location	Breeding shows	Year of the show	Judged in	Rider	Eigandi	Conformation	Rideability	Total	View
IS2006235848	Planta	Skrúð	2500	IS	Kynbátasýning á Dalvík	2011	IS	Þorvar Þorsteinsson	Susanne Braun	8.61	8.08	8.29	View
IS2006235848	Planta	Skrúð	2500	IS	Kynbátasýning á Dalvík	2012	IS	Þorvar Þorsteinsson	Susanne Braun	8.64	8.4	8.5	View
IS2006266016	Þruma	Húsavík	2500	IS	Síðsumarsýning á Vesturlandi	2012	IS	Jakob Svavar Sigurðsson	Hörður Eiríksson	8.19	8.02	8.09	View
IS2006276135	Herma	Hryggstökk	3700	IS	Melgerðismelar	2014	IS	Guðröður Ágústsson	Snorri Guðröðarson	8.28	8	8.12	View
IS2008286298	Gleði	Kaldbak	2500	IS	Borgarfjörður, fyrri vika	2014	IS	Steingrímur Sigurðsson	Sigmundur Jóhannesson	8.09	8.68	8.45	View
IS2008286298	Gleði	Kaldbak	2500	IS	Landsmót 2014 - Hella	2014	IS	Steingrímur Sigurðsson	Sigmundur Jóhannesson	8.09	8.33	8.23	View

How many daughters of a certain stallion (our example here is Blær frá Torfunesi) have a specific assessment of 9.0 or higher for tölt? Again, you can use the “Search for Assessments” tool under the HORSE menu on WorldFengur to find out.

daughters of Blær frá Torfunesi, for example, who have a specific assessment of 9.0 or higher for tölt. Under the HORSE menu, select Search for Assessments. Enter Blær's FEIF-ID number (IS1999166214) under Sire. Leave the FEIF ID space blank and select "Mare" from the Gender pull-down menu. You can specify the fate of the horses (living or deceased), as well as the current location if you wish. Enter a tölt score of 9.0-10.0. This narrows the search to all mare offspring of Blær with a score of 9.0 or higher for tölt. Hit "search." A window will open showing all the assessments of Blær's four daughters that received 9.0 or higher for tölt; two of them, you will notice, were assessed twice.

VIRTUAL MATE SELECTION

Virtual Mate Selection, under the HORSE menu, is a great tool to play with when you are contemplating breeding your horse. It calculates the heritability of the dam's and sire's traits and gives you

an estimated outcome for their possible offspring. Remember that this tool does not take into consideration environment, training, or upbringing. It just uses the dam's and sire's BLUP values to calculate how strongly certain traits are likely to be inherited. (To learn more about BLUP, see "Understanding BLUP Breeding Values" in Issue Three 2009 in the Quarterly's online archive at www.icelandics.org.)

Virtual Mate Selection can be used in conjunction with information on a horse's pedigree, scores, and current offspring. It will also give you a possible genetic color prediction. Recently WorldFengur added a probability percentage for producing four-gaited or five-gaited horses, as well.

To do a Virtual Mate Selection, write down the sire's and dam's registration numbers. Under the HORSE menu, click on Virtual Mate Selection and enter these numbers in their respective fields (with no spaces or dashes). Press Forward. The program will do the rest for you. If the parents are too closely related, and there

is a possibility of inbreeding, the program will show a red percentage number in the inbreeding coefficient. The higher the BLUP accuracy percentage is for the parents, the more accurate the prediction will be. This is also an interesting tool if used in retrospect.

SELECT STALLIONS

Select Stallions, under the HORSE menu, is a new function in WorldFengur that calculates the best choice of stallion for a mare, based solely on BLUP values. You insert the mare's FEIF ID number and select a BLUP criteria, for example BLUP Pace. You decide on the percentage of inbreeding acceptable in your potential offspring, the country in which the stallion stands at stud, the minimum BLUP accuracy percentage (the higher the percentage, the more likely the result), and the number of stallions resulting in the search.

REPORTS

If you would like to narrow your search down to reports on a specific horse, click on REPORTS on the main menu and select Basic Report. Let's say you would like to see a list of the highest assessed offspring of a horse. Simply enter that horse's FEIF ID number, select List of Offspring, and then Offspring with highest assessment. Click Forward, and the horse's basic information will show up listing the offspring with the highest scores.

A new very cool search function is Assessment Average under REPORTS. When you enter the stallion's FEIF ID and hit Forward, a window will open showing you a list of all the conformation and rideability attributes, organized by sire, dam, and offspring. It actually calculates all the scores the stallion, mare, and judged offspring have received. Clicking on the small magnifying glass icon next to the scores of the offspring brings up a window with all the horses included in the average. This is a very valuable search function when deciding which stallion to use, as you can actually compare the scores his judged offspring received for each specific trait and also see what the average score of the dam was.

If you select Breeding Evaluation under

The stallion's FEIF ID number IS1999166214 *Blær frá Torfunesi - UELN: 352002999166214*
 The mare's FEIF ID IS2008225398 *Barónessa frá Ekru - UELN: 352002008225398*
 Forward

International BLUP
 Help - Explanations

Mating between sire IS1999166214 - *Blær frá Torfunesi* (Colour code: 2500) and dam IS2008225398 - *Barónessa frá Ekru* (Colour code: 1500)
 R% = 2,726

Potential offspring - BLUP - F% (inbreeding coefficient)

Height	Mane	Shet	Walk	Head	Neck	Back	Prop	Legs	Corr	Hoof	Tölt	Trot	Pace	Gallop	Form	Spir	Conf	Rid	Tot	F%
0,6	104	107,5	103	101	102,5	108	105	112,5	100	107,5	114	110	108	108	113	113	111	114,5	116	1,363

Possible colour and DMRT3 genotypes and genotype probabilities in the Sire (9 loci)

Loci	E-locus	A-locus	C-locus	D-locus	G-locus	Z-locus	To-locus	Rn-locus	DMRT3-locus
Possible Genotypes	E-	aa	C-	dd	gg	zz	tt	rr	AA
Genotype	LL	1,0	0,0	1,0	0,0	0,0	0,0	0,0	0,0
Probabilities	LI	0,0	0,0	0,0	0,0	0,0	0,0	0,0	0,0
Probabilities	II	0,0	1,0	0,0	1,0	1,0	1,0	1,0	1,0

Possible colour and DMRT3 genotypes and genotype probabilities in the Dam (9 loci)

Loci	E-locus	A-locus	C-locus	D-locus	G-locus	Z-locus	To-locus	Rn-locus	DMRT3-locus
Possible Genotypes	ee	aa	CC	dd	gg	zz	tt	rr	CA
Genotype	LL	0,0	0,0	1,0	0,0	0,0	0,0	0,0	0,0
Probabilities	LI	0,0	0,0	0,0	0,0	0,0	0,0	0,0	1,0
Probabilities	II	1,0	1,0	0,0	1,0	1,0	1,0	1,0	0,0

Possible colour and DMRT3 genotypes and genotype probabilities in the potential offspring (9 loci)

Loci	E-locus	A-locus	C-locus	D-locus	G-locus	Z-locus	To-locus	Rn-locus	DMRT3-locus
Possible Genotypes	e-	aa	C-	dd	gg	zz	tt	rr	-A
Genotype	LL	0	0	1	0	0	0	0	0
Probabilities	LI	1	0	0	0	0	0	0	0,5
Probabilities	II	0	1	0	1	1	1	1	0,5

Explanatory table with coat colour genotypes and phenotypes
 Help - Explanations

Probability of 4-gaited offspring = 50 % ; Probability of 5-gaited offspring = 50 %

Possible coat colour phenotypes and the probability of each phenotype in the potential offspring

Probability %	Coat colour (colour code)	Picture
100	Black (2200-2700)	

Virtual Mate Selection, under the HORSE menu, is a great tool to play with when you are contemplating breeding your horse. Here's the kind of offspring we'd see if we mated our sample stallion, Blær frá Torfunesi, with the mare Barónessa frá Ekru.

Select stallions - Choose stallions for your brood mare

The mare's FEIF ID: IS2008225398 Barónessa frá Ekru - UELN: 352002008225398

Criteria for selection: BLUP Pace

Restrictions:

Restrictions on inbreeding (F%) in potential offspring: 5

Country in which the stallion is on stud: United States

Minimum accuracy (R₁₇%) of the stallion's BLUP index: 60

Maximum length of the list with selected stallions: 50

Forward

International BLUP
Help - Explanations

The BLUP table for the mare IS2008225398 - Barónessa frá Ekru

Height	Mare	Stwt	Walk	Head	Neck	Back	Prop	Legs	Corr	Hoof	Tölt	Trot	Pace	Gallop	Form	Spir	Conf	Rid	Tot
0.9	100	115	97	97	106	109	109	93	98	102	117	115	89	112	118	112	105	108	109

Rank criteria and restrictions: Criterion: BLUP Pace | F%: 5 | R₁₇: 60 | Country: CA / US

Rank of max 50 possible stallions - Click on a link (in the first column) for inspection of any potential mating

Stallion										Foal			
FEIF ID	Name	Farm (location)	Criterion	Conformation	Rideability	Total score	R ₁₇ %	Criterion	Conformation	Rideability	Total score		
DE1997104468	Snúður	vom Lippertof	123	92	109	106	73	106.0	98.5	108.5	107.5		
IS1997165492	Sleipnir	frá Eri-Rauðaleik	120	102	112	111	86	104.5	103.5	110.0	110.0		
IS2005137340	Sporður	frá Berg	118	109	119	119	85	103.5	107.0	113.5	114.0		
IS1994175280	Kvittur	frá Viðvöllum Bæmi	116	109	101	103	82	102.5	107.0	104.5	106.0		
IS1994185027	Þór	frá Prestabakka	116	106	108	109	91	102.5	105.5	108.0	109.0		
IS1990187289	Faldur	frá Tófum	115	118	109	113	87	102.0	111.5	108.5	111.0		
IS2004186688	Vigni	frá Holtamúla 1	114	115	114	117	78	101.5	110.0	111.0	113.0		
IS2001187041	Irðisur	frá Hvammi	114	121	115	119	92	101.5	113.0	111.5	114.0		
IS1991135551	Irðisur	frá Imri-Skejabrekku	114	106	101	103	87	101.5	105.5	104.5	106.0		
IS1997157025	Vifill	frá Keldudal	113	98	103	102	84	101.0	101.5	105.5	105.5		
IS2006187001	Kjói	frá Kjami	112	114	109	112	80	100.5	109.5	108.5	110.5		
IS1995128201	Elvar	frá Reykjavík	112	99	108	107	76	100.5	102.0	108.0	108.0		
IS1995158310	Tjaldur	frá Hölum	112	111	105	108	87	100.5	108.0	106.5	108.5		
IS1994157347	Oylir	frá Hafsteinstöðum	111	108	109	110	78	100.0	106.5	108.5	109.5		

"Select Stallions," under the HORSE menu, is a new function in WorldFengur that calculates the best choice of stallion for a mare, based solely on BLUP values. Here are results for our sample mare, Barónessa frá Ekru.

REPORTS, a window will open that allows you to enter a BLUP value and select specific criteria to narrow your search down. You can select mare or stallion, enter a BLUP value, change the number of horses in the report, and select the country of current location. Use the Sort By drop-down menu, change ascending or descending order, and enter the number of judged offspring. This is another highly advanced search function, which makes WorldFengur so exceptional.

SHOW RESULTS

To view information on all breeding shows, click on BREEDING SHOWS on the main menu. You can choose to find the results of a specific breeding show by entering either a year or the name of the show. A drop-down menu narrows the search further by allowing a country to be selected. A list of breeding shows will display, which you can then look at individually by clicking on the name of the show.

When the show is displayed, all the horses shown will be listed alphabetically.

You can change that order by clicking on the header of the search criteria you are most interested in. For example, if you would like to have the horses listed by highest score to lowest score, simply click on Total and the table will reorganize. The page icon at the end of every horse's row of data brings up the score sheet. The printer icon formats the score sheet for printing.

If you are interested in the collected data on all the horses, these printing functions are available along the top of the page: Print record on all horses in the show; Print assessments from this show; Print extended records for all horses in the show; and Assessments overview. In Assessments overview, you can even click on the small Excel icon at the top of the page, and it will allow you to download the data to your computer as an Excel file.

Another search function under BREEDING SHOWS is Highest Assessments, as mentioned above. This will bring up a calculated list of all horses judged that year, starting with the highest judged ascending in age and gender categories.

Competition results are now entered into WorldFengur as well. These can be accessed by clicking on Competition under

Assessment average

FEIF ID: IS1999166214

Name: Blær

Name of the farm (studname): Torfunesi

Attribute	Sire - Average	Number of assessments	Offspring - Average	Number of assessments	Dam - Average	Number of assessments
Head	8		4 7.86		111 7.67	358
Neck-Withers-Shoulders	7.63		4 8.11		111 8.2	358
Back and Croup	8		4 8.09		111 7.79	358
Proportions	8		4 8.05		111 7.86	358
Legs	8.88		4 8.42		111 7.79	358
Joints	6.63		4 7.63		111 7.6	358
Hooves	8.75		4 8.12		111 7.88	358
Mane and Tail	8.38		4 7.5		111 6.58	287
Conformation	8.06		4 8.07		111 7.88	358
Tölt	8.5		4 8.03		103 7.94	332
Trot	8.75		4 7.54		103 7.67	332
Pace	8.5		4 7.62		103 6.64	332
Gallop	8		4 7.79		103 7.96	332
Spirit	8		4 8.24		103 8.24	214
Temperament		0			0 8.07	118
Character		0			0 7.8	118
General Impression	8.25		4 7.93		103 8.04	332
Walk	7.88		4 7.67		103 7.48	227
Rideability	8.54		4 7.88		103 7.77	332
Slow tölt	7.75		4 7.69		103 7.78	227
Canter	6.88		4 7.21		103 7.53	169
Total	8.35		4 7.96		103 7.81	332

A new very cool search function is "Assessment Average" under REPORTS. This window shows you a list of all the conformation and rideability attributes, organized by sire (in this case our sample stallion, Blær frá Torfunesi), dam (meaning all the mares he has mated with), and all their offspring.

Breeding show	FEIF Breeding show Vernon 15	Date	20.06.2015 - 21.06.2015		
Association	Canadian Icelandic Horse Federation	Show number	01	Year of a show	2015
Area	10 - British Columbia	Country	CA - Canada		
Calculation formula	FIZO 2010 - 40% / 60%				
Chief judge	SE0000119393 Herdis Reynisdottir				
Judge 2	IS1410552169 Sigbjörn Björnsson				
Judge 3					
Show manager	CA0005066059 Arnold Faber				
Other employees					
Period of registration		Registration status	Closed		
Number of horses	26 [Unverified DNA: 0]				
Date locked	06.07.2015				

Horses in this show	Conformation	Ridden abilities	Total	Rider	Trainer
US2007103535 Ali from Dalalif	7.98	7.95	7.96	Lucy Nold	
CA2010102372 Avadli from Triple D	7.91	7.3	7.55	Trausti Þór Guðmundsson	
CA2005202040 Björk from Tolt Away	8.02	7.06	7.45	Svanhildur Stefánsdóttir	
CA2008202445 Blaka 08 from Fitjarnyr	7.81	8.42	8.18	Danielle Fulsher	
US2008103875 Blazr from Sand Meadow	8.08	7.55	7.76	Hanna Dilts	
CA2011102407 Blazvar from Vindadalur	8.05			Elisabeth Ohm	
CA2001101926 Bragur from Fitjarnyr	7.44	7.18	7.29	Janne Walas	
CA2009202334 Dis from Fitjarnyr	7.84	7.5	7.64	Skapti Ragnar Skaptason	
CA2011202362 Drift from Bonaventure Farm	7.96			Verena Pecsy-Barber	
CA2011202405 Dúka from Vindadalur	8.07			Hanna Dilts	
US2011104489 Gláður from Creekside Farm	7.98			Hanna Dilts	
CA2008202424 Gletta from Fitjarnyr	7.83	7.15	7.34	Skapti Ragnar Skaptason	
CA2006102393 Hemmingur from Fitjarnyr	7.78	7.85	7.82	Janne Sophie Walas	
CA2006202422 Hrima from Fitjarnyr	7.93	7.43	7.63	Danielle Fulsher	
CA2001202287 Kella -	7.96	7.06	7.42	Skapti Ragnar Skaptason	
CA2007202228 Meyla II from Fitjarnyr	7.73	7.4	7.53	Skapti Ragnar Skaptason	
CA2011102403 Mídas from Vindadalur	7.96			Lucy Nold	
CA2011202375 Nipa from Fitjarnyr	8.06	7.28	7.59	Skapti Ragnar Skaptason	
CA2004201895 Rikka Pia from Fitjarnyr	8.29	7.25	7.67	Trausti Þór Guðmundsson	
CA2005202281 Sida from Fitjarnyr	8.41	8.09	8.22	Skapti Ragnar Skaptason	
CA2003201802 Siella from Harlands	7.72			Skapti Ragnar Skaptason	
CA2005202225 Stelpha II from Fitjarnyr	7.78	7.67	7.7	Trausti Þór Guðmundsson	
CA2010102335 Tyr II from Fitjarnyr	8.05			Danielle Fulsher	
CA2007202428 Tyrá 07 from Fitjarnyr	8.2	7.49	7.77	Trausti Þór Guðmundsson	
CA2007202368 Velga from Fitjarnyr	7.85	7.08	7.39	Janne Sophie Walas	
CA2011102378 Viðar from Fitjarnyr	7.91	7.66	7.76	Trausti Þór Guðmundsson	

If you click on BREEDING SHOWS on the main menu, you can find the results of a specific breeding show by year or name. Within each show, the horses are listed alphabetically but you can change that order by clicking on the header of the search criteria you are most interested in.

BREEDING SHOWS. You again have the option to either enter the year or the name of the show, followed by the club, and/or the country. All competition results from 2004 on are accessible.

An additional tab Competition results (Iceland) was added in 2013; it lists the 30-50 highest scoring horse/rider teams in Iceland in all tests, from gæðingakeppni to young adult classes.

COLOR TABLE

If you are in the process of registering your foal and need to find the correct color code for your horse, simply go to HORSE menu and click on Color table. This will bring up a window with all the color possibilities and their codes. You can enter a color and markings in the search box and then hit Photo to see a variety of photos showing the color combination you picked.

HORSE NAMES

All registered Icelandic horses must have an Icelandic name. This fun feature on the main menu allows you to find out what the names mean and how many horses have a given name. If you select a category from the group section and hit Search, it will give you a list of names and specify if they are male or female. Names highlighted in blue allow you to click on them and a window will open with the explanation and translation and, in some cases, the pronunciation.

PERSON

Under the PERSON search on the main menu you will find several search criteria. You can search for a person, a horse owner, a veterinarian, an authorized marker (like a microchip or freeze brand), or a microchip supplier. You can search either by entering a personal identification number or by entering the person's name.

You can narrow the search by selecting a country, but you do not have to. Unfortunately, this page does not give you the option of entering Icelandic letters on the screen (as does the Horse Search page), which would be beneficial for those living outside of Iceland, since not all of our computers come with Icelandic keyboards.

Once you have found a name, you can click on it and see the contact information. Another shortcoming of this page, however, is that there is currently no way you can update your own contact information directly in WorldFengur. Instead, you have to contact the registrar in your country and ask them to update it for you.

PADDOCK

The Paddock is a new WorldFengur feature that was set up so you can see immediately a list of all the horses you own and access current information on your horses. The page is has four tabs: My Horses, Deceased, Sold, and Exported. If you would like to make a correction to any information on the horses you own, simply click on the speech bubble icon at the far right, and a window will open that allows you to send a comment on that horse to WorldFengur. If you check Please send this remark/correction to the registration office, it will also be sent to your country's registrar. This is a great feature to keep WorldFengur updated and current. If horse owners wish to have their registration certificates updated, they can send them to the USIHC Registry directly from WorldFengur. I suggest you check your horses' status in WorldFengur and make any corrections needed.

Now that you have had a little taste of all the things you can find out about your own or other people's horses, remember that there is life after WorldFengur. It can be quite addicting! Go ride and get some fresh air!

Editors' note: We want to thank Martina Gates for allowing us to reprint this comprehensive how-to article, originally written for Tölt News when she was owner and editor. A passionate Icelandic horse breeder, rider, writer, and photographer, Martina used WorldFengur almost daily and taught herself how to find its wealth of information. When the administrators of WorldFengur heard about her article, they asked Martina for permission to post it on their website, and they awarded her a lifelong honorary membership—not least for being by far the most frequent user of the database.

BLOOD RESEARCH: UPDATE

BY TRACY STOKOL AND BETTINA WAGNER

The Icelandic Horse Reference Interval study at Cornell University, also known as the USIHC Blood Profile Project, is funded through generous support by the USIHC and donations from many Icelandic horse owners.

To date, the sample collection period for our project has been completed, and we would like to thank all Icelandic horse owners who agreed to have a blood sample from their horse taken. We have compiled results from 121 horses and are currently looking at their blood smears and quantifying certain changes in red blood cells, white blood cells, and platelets (this has not been done before). Once this labor-intensive manual verification is done, we will start analyzing the data thoroughly, with the goal of generating reference intervals for the clinical pathologic testing of Icelandic horses in the U.S.

Veterinarians use clinical pathologic data, including routine blood counts and chemistry panels, to determine what is wrong with a sick or ailing horse. From changes in blood results, we can identify diseases or conditions such as inflammation. We generally detect these changes in blood results by comparing the results from an individual horse to a reference interval. This reference interval is usually established using large numbers of adult clinically healthy horses (preferably 120 or more) of both sexes. In the past, these clinically healthy animals have been of various breeds of horse. However, we now know that genetics influences blood results.

This means that in a specific breed such as the Icelandic horse, an abnormal result (i.e. high or low) compared to a reference interval derived from other horse breeds may actually be a normal finding for Icelandic horses. Conversely, a seemingly normal result (one that falls within the reference interval derived from other breeds) may actually be an abnormal finding for Icelandic horses. Thus, establishing reference intervals for normal blood values for the Icelandic horse is important, because it allows a veterinarian to make the best decision regarding the health or disease status of an individual Icelandic horse.



Bettina Wagner of Cornell. Photo by Andrea Barber.

In Germany a few years ago, a study of reference intervals for clinical pathologic data in Icelandic horses was published (see Schusser et al. 2014 in *Pferdeheilkunde*), and the editors of *The Icelandic Horse Quarterly* asked us to explain how the USIHC-funded study at Cornell differs from—and improves upon—this study from the University of Leipzig.

First, it is important to realize that the reference interval established for any species or breed is quite dependent on the instruments and methods used to perform the testing, as well as on the conditions under which the testing was performed, including how the samples were collected and how they were submitted to the laboratory. Results established in one country may not be applicable to horses in another country.

Second, the German study only tested 73 Icelandic horses, and many important results, such as hematocrit, leukocyte count, and calcium, were grouped with Haflingers and ponies.

Third, the Icelandic horses tested ranged in age between one and 14 years of age. Icelandic horses are not fully mature until they are at least two years of age,

and the age of the animal affects some blood parameters; for instance, phosphate concentrations and lymphocyte counts are higher in younger animals. Including young animals in a reference interval study could, therefore, bias the results.

Fourth, the German study also did not test for some important tests, including the marker of liver injury, SDH.

Finally, all the samples in the German study were analyzed the same day they were collected, which does not represent a real-life situation, in which veterinarians submit samples to a referral diagnostic laboratory for testing. Shipment of such samples results in a minimum one-day delay between the sample collection and the analysis. We know that the storage of samples, even under ideal conditions, can result in changes in blood results, and these changes can either mimic or obscure a disease. For instance, glucose concentrations can decrease with storage. Thus, it is important to establish reference intervals from animals in which samples are collected under real-life conditions.

Unlike the German study, the USIHC-funded study is determining reference intervals for adult Icelandic horses from samples that were sent from all over the U.S. to our laboratory. These samples took a day to get to our laboratory and represent real-life testing. We were also fortunate to collect and analyze fresh samples collected from 45 horses in Dr. Wagner's herd at Cornell University. We plan to compare the data from these 45 horses to the mailed-in samples from around the country to determine what changes occur in the blood of Icelandic horses with storage. The comparison will identify which blood parameters are time-sensitive and which ones are not. It will also provide results for both scenarios, which will support the use of routine blood counts and chemistry panels in Icelandic horses that are diagnosed in the field by a local veterinarian (sample arrives with some delay in the testing laboratory) and also in horses that are hospitalized (same-day testing).

For more information on the Blood Profile Project, contact USIHC Board member Andrea Barber at bpproject@icelandics.org.

CHAMPIONS OF THE EAST

BY JESS HAYNSWORTH

I believe it was about two years ago, after the Kentucky Icelandic Horse Show, that Carrie Lyons Brandt and I first had a conversation about ways to make the Icelandic sport world in the U.S. more exciting. The idea we discussed was one that had been on my mind for years—a proper show circuit and championships, the likes of which we see in other equestrian sports, and even within our own breed in Iceland and Europe. Growing up on the Hunter/Jumper A Circuit, I remember summers spent showing on weekends, earning points toward state and regional finals, and winning championships. It didn't matter that I was just a kid, or only skilled enough to jump small fences, or that my pony was a mixed-breed. I was given the opportunity to work toward an attainable goal and to be recognized for my hard work, determination, and success. It wasn't so much about the satin ribbons and plastic trophies themselves, it was about having something tangible to show my family, my non-horsey friends,



Alexa Zinser on Leifa frá Nýjabæ, champion of the Novice Division. Photo by Charlotte Reilly.

my teachers at school—something I could display in my room or hang on my pony's stall door to show that we had worked hard and achieved something together.

In our Icelandic sport in the U.S., we have not always given our riders the opportunity to feel successful. We have the National Ranking program—and this is a fantastic program at the national level—but it only rewards the top rider in each division. For many of us, being the very best in the country is a relatively unattainable goal. There will always be someone with better access to USIHC-sanctioned tracks, trainers, clinics, top horses, etc. This is the nature of all equestrian sports, and yet our particular sport seems to struggle to gain momentum in the U.S. more than other sports do, even as it thrives in Europe and Iceland. I believe that we need similar programs at the regional and state levels to give our riders attainable goals, to build a sense of community, and to encourage, celebrate, and reward the hard work and dedication of our amateur (meaning non-professional) riders especially, at all levels of participation.

IT'S THE JOURNEY

Amateurs make this sport happen, from hiring instructors, trainers, farriers, shippers, and clinicians, to lodging their horses at boarding barns and paying for competition fees. They buy horses for themselves and for their families, breed their mares, send their young horses out for training, hire pros to ride their horses in breeding and sport shows, and, if we are lucky, sign up to compete themselves. They fill the Youth, Novice, Intermediate, and Pleasure divisions, and often the Green Horse and Open Divisions, too. They take time off from work or school and truck their horses across the country to compete in USIHC-sanctioned shows, at great expense to themselves. Without the support and attendance of our amateur riders, these sports simply cannot happen. We don't even have enough pros in this country to fill the Open classes in most cases. Riding, much like yoga, is a practice: It's all about the journey, not the destination. If we want



Alicia Flanigan, champion of the Youth 12-and-Up Division, with her mare Brá frá Fellskoti in 2015. Photo by Martina Gates.

amateurs to go on this journey with us, spending their time and money on our sport so that we can all enjoy more competitions and events as a community, then we need to let them know that we see how hard they work, that we appreciate their time and effort, and that we recognize their accomplishments at all levels.

This was what I expressed to Carrie during that first conversation and, as it turned out, she had had similar ideas—and so had more than a few others. So we formed a committee with representatives throughout the Eastern half of the U.S.—Carrie Brandt and Kathryn Love from Kentucky, me (Jess Haynsworth) from the Northeast Icelandic Horse Club (NEIHC), Kevin Draeger from the Flugnir Club, and Antje Freygang from the Frida Icelandic Riding Club—and we began a new project, The Eastern Regional Icelandic Horse Championships (ERIHC).

THE 2016 SEASON

This past show season was the first ever that a show circuit and championships of this nature existed in the U.S. Private Division Sponsors each donated \$100 towards ribbons and trophies for the top five highest scoring riders in their division, as well as each donating a prize worth at least \$100 to their division's champion.

Riders signed up on the ERIHC website, declaring the division in which they wanted to earn points towards a Championship. (Note that riders were not excluded from competing in other divisions, but we made the decision to only count their scores from the division they declared, therefore preventing one rider from winning more than one division). The only requirements were that riders had to sign up ahead of time, and then compete in two or more USIHC-sanctioned shows in the region in 2016. Riders could compete on more than one horse, therefore making the Champion-



Sydney Horas on Hrönn frá Hófgerði. Sydney was the reserve champion of the Group Open Four Gait division, and Hrönn was the champion of the Green Horse division, ridden by both Sydney and Terral Hill during the season. Photo by Martina Gates.



Kathy Love on Pegasus frá Skyggni, champion of the Group Open Four Gait Division. Photo by Shaila Sigsgaard.

ships accessible to people who don't own their own horses and instead lease horses or catch-ride for competitions when they can. At the last moment, we came up with an idea to allow owners to sign their horses up for the Green Horse division, and then have their horses ridden in that division by professionals, thereby creating an opportunity to reward owners who breed or raise quality young horses, even if they aren't competition riders themselves.

There was a learning curve for us as organizers this first year. In the 2017 season, USIHC Board member Leslie Chambers will be joining the committee, and we will take all that we learned this past season and apply the appropriate changes going forward. But the bottom line is this: At the end of this show season, the top riders from each division walked away with something special to show for their efforts. Regardless of age, level, or even whether or not they owned their own horses, riders who put in the time, money, effort, travel, and long practice

hours required to compete in two or more USIHC-sanctioned shows were rewarded and recognized as the important contributors to our sport that they are. They were congratulated for their successes, given ribbons and beautiful wooden picture frames inscribed with their division and title as trophies, and now have something tangible to show to their friends, families, and coworkers when they're asked why they go on these expensive, laborious excursions with their horses. From that perspective, the ERIHC project has already been a success.

In 2017, we hope that more of the riders who sign up initially will fulfill the requirements of competing in two or more USIHC-sanctioned shows, thus making them eligible for the end-of-year awards. Many of the top-scoring riders early on in the season did not manage to compete in a second competition, which meant that we did not have five award-winners in every division this year. In the future, my dream would be to see a special championship show at the end of the

season for qualifying riders in the region. While this is still a dream for the future, perhaps this first year of the ERIHC was a step towards that goal.

Below, you will meet this year's top-scoring riders in each division. They come from all walks of life, from different training backgrounds, and different parts of the country, some even come from abroad. They are youth riders, pros, and adult amateurs. Some own their own horses and some don't. All were given the equal opportunity to sign up and earn points in whichever division they chose. The riders listed below distinguished themselves as the riders with the highest-scoring averages in their respective divisions. Next year, the champions could be anyone—maybe even you. Thank you to all of the riders, sponsors, organizers, and participants who made the first ever Eastern Regional Icelandic Horse Championships possible. We look forward to next year's Championships!

NOVICE DIVISION

CHAMPION: ALEXA ZINSER

Alexa is a young adult rider from Kentucky who does not own her own horse but “takes every opportunity she can to learn and compete,” says her instructor, Carrie Lyons Brandt. Over the course of the circuit,



Kenna Kremer cantering on Guldís frá Hellu. Kenna was the champion of the Youth 11-and-Under division. Photo by Charlotte Reilly.

Alexa rode multiple horses, but most will remember her on the black and white pinto mare, Leifa frá Nýjabæ, with whom she shares a close bond. “She brought out amazing moments in Leifa frá Nýjabæ that no one thought were possible from a lesson

and trail horse,” says Brandt. Alexa finished with an impressive average score of 4.29. There were a number of other riders in the novice division who signed up to earn points at the start of the season, but only managed to compete in one show on the circuit, therefore becoming ineligible for end-of-year awards. We hope next year to see more Novice level riders competing in two or more shows! *The Division Sponsor was Mad River Valley Icelandic Horses, and the Championship Prize was a custom mixed-media portrait by Canadian artist Jen White.*

INTERMEDIATE FOUR GAIT DIVISION

CHAMPION: MARTIN NIELSEN

RESERVE CHAMPION: SHAILA SIGSGAARD

THIRD PLACE: TAMMY MARTIN

FOURTH PLACE: SUSY OLIVER

This division was particularly exciting because Martin and his wife, Shaila, battled it out for the top spot, ultimately finishing with Martin as champion with an average score of 5.3, and Shaila as Reserve Champion with a score of 5.05. However, the couple bred Martin's mount, Svás frá Raunsbjerggaard, together and take turns riding her at home, so this was really a win for the entire family. “Shaila and I bred



Grace Strausser on Spurning frá Steinnesi (left), and Carrie Lyons Brandt on Kviká from Four Winds Farm. Grace won third place in the Youth 12-and-Up Division and piloted Spurning to 5th place in the Green Horse Division as well. Kviká, owned by Ron and Sherry Hoover of Beat'n Branch Icelandics and shown by Carrie Lyons Brandt, won 4th place in the Green Horse Division. Photo by Charlotte Reilly.

Svás in Denmark, and we still own her mother Rimma there,” says Martin. “She is very cool and does not really get nervous. I rode her in the Knights of Iceland show at Breyerfest this summer in front of some 4,000 people, and she didn’t flick an ear.” That said, Martin says that the seven-year-old mare can get excited on the oval track and that she is still working on consistency as a competition horse. “All in all it was a good season, and Svás is slowly but surely developing in the right direction,” he says. Third-place rider Tammy Martin and her horse, Kvintett, “have drawn attention for their great partnership and positive attitude in the show ring,” says Carrie Lyons Brandt. The fourth-place rider, Susy Oliver, competed on her homebred American gelding, Kelli from Tölthaven, with impressive results, even winning the featherlight prize for harmonious riding at the Kentucky Show. *The Division Sponsors were the Frida Icelandic Horse Club (FIRC) and Antje Freygang, and the Championship Prize was a gift basket full of designer tack and goodies.*

INTERMEDIATE FIVE GAIT DIVISION

CHAMPION: GABRIELLE PITTMAN

RESERVE CHAMPION: CHARLOTTE REILLY

Gabrielle “Ellie” Pittman is a rider well known in the Icelandic horse community for being one of the most helpful and hardworking young riders around. She won the championship this year in spite of a number of challenges, including her own mare sustaining an injury early in the season. Ellie rode a variety of horses in as many shows as possible, and her hard work paid off—she finished the season with a score of 4.67. She was closely followed by adult amateur rider Charlotte Reilly. Aboard her domestic-bred chestnut charger, Sprettur from Destiny Farms, Charlotte finished with a score of 4.33. Sprettur “has proven himself to be a very versatile horse,” says Charlotte of the 11-year-old gelding. Once a first-prize stallion, Sprettur was trained primarily on flat, well-groomed tracks, but Charlotte

has unlocked his love of the wilderness. “He just loves going out with the big horses, always in the lead,” she says. This was the pair’s first year competing in five gait and loose rein tölt classes. “Sprettur knows more about competition than I do, but he has been very patient with me,” says Charlotte, who says the pair will return in 2017 to try to improve their scores in this division. *The Division Sponsor was Léttleiki Icelandics, and the Championship Prize was an Eques Kosmos saddle.*

GROUP OPEN FOUR GAIT DIVISION

CHAMPION: KATHRYN LOVE

RESERVE CHAMPION: SYDNEY HORAS

Kathy and Pegasus frá Skyggni have become an iconic team in the U.S., and this year they finished with a superb average score of 6.42. Says Kathy, “Peg and I have been a team ever since I first rode him in sideways rain and snow in Iceland in January 2006. The highlight for us was the World Championships in 2007 and



From left to right, Shaila Sigsgaard, reserve champion of the Intermediate Four Gait Division; Alicia Flanigan, champion of the Youth 12-and-Up Division; and Martin Nielsen, champion of the Intermediate Four Gait Division. Photo courtesy of Léttleiki Icelandics and Shaila Sigsgaard.

2009, and the low has been layoffs and coming back from 2011 through 2015 due to injuries in both of us, so 2016 brought the sweetness of restoration. Having the goal of ERIHC was a great help. We did three of the shows and, even though our collective age is approaching 90, we did well. Thanks to the organizers and sponsors of ERIHC and Pegasus: Ég elska þig.” The Reserve Champion, Sydney Horas, showed incredible dedication, traveling all the way from Canada to compete in four separate shows throughout the region. “It was an amazing year,” wrote Sydney on her family’s OnIce Farm’s Facebook page. “I have to thank all the show organizers and coordinators, and of course our friends at Léttleiki Icelandics, for allowing me to ride two amazing horses in my most successful year yet!” Aboard Maðís from Hanging Valley, Hrönn frá Hófgærði, and Djasn frá Sigmundarstöðum, Sydney achieved excellent scores and did it all with a smile on her face, finishing with an impressive score of 5.66. *The Division Sponsor was the Northeast Icelandic Horse Club (NEIHC), and the Championship Prize was a \$100 gift certificate to Tolt Tack.*



Terral Hill on Sporður frá Bergi. Terral was the champion of the Open Give Gait division. Photo by Shaila Sigsgaard.



Caeli Cavanagh on Dropi frá Blöndousi. Caeli was the reserve champion of the Open Four Gait Division. Photo by Shaila Sigsgaard.

OPEN FIVE GAIT DIVISION

CHAMPION: TERRAL HILL

Terral and the pinto stallion, Sporður frá Bergi, have become fan favorites in competitions and Knights of Iceland performances around the country. Under Terral’s careful guidance, the larger-than-life pinto stallion smoked down the track this year, finishing with a huge year-end average of 6.63. The Open Five Gait Division, considered by many to be one of the most difficult and demanding divisions in our sport, did not have many participants this year; we hope to see more riders taking a chance and earning points towards year-end awards in this division next year! *The Division Sponsor was Creekside Farm, and the Championship Prize was The Icelandic Horse coffeetable book.*

OPEN FOUR GAIT DIVISION

CHAMPION: CARRIE BRANDT

RESERVE CHAMPION: CAELI CAVANAGH

THIRD PLACE: JESSICA HAYNSWORTH

The Open Four Gait Division was unique in that the Champion, Carrie Brandt, and the

Reserve Champion, Caeli Cavanagh, rode the same two horses: Veigar frá Lækjamóti and Dropi frá Blönduósi. “Caeli and I trained and competed on both horses, trading off and on throughout the year,” says Carrie. “Both are incredible four-gaiters but complete opposites in the way they move, so it was really challenging and exciting switching between the two horses.” Ultimately, Carrie came out on top with a season average of 6.72, the highest finishing score in any division this year. The third-place rider was me (Jess Haynsworth) on Vigri frá Vallanesi, a gelding that I started under saddle as a four-year-old and have raised and trained myself for the past four years in Vermont. While we don’t have a track to practice on at home, we enjoy any opportunity to travel and compete. This year, with the help of Curtis Pierce, who made shipping accessible from the Northeast to several shows on the Circuit, we traveled around 3,180 miles to three USIHC-sanctioned competitions, achieving our best scores yet. *The Division Sponsor was Pegasus Flughestar, and the Championship Prize was a free breeding to the first-prize stallion Pegasus frá Skyggni.*

YOUTH 11-AND-UNDER DIVISION

CHAMPION: KENNA KREMER

Kenna was the only 11-and-under rider to complete two or more competitions in the youth division. She impressed everyone with her harmonious riding and positive attitude, and many may be surprised to learn that this was her first year riding in competitions! Kenna rode the mare Gulldís frá Hellu, with what her trainer Carrie Brandt describes as “fantastic results,” finishing with an average score of 4.25. “Kenna enjoys competing because she gets to hang out with horse and human friends,” says her mother, Kristin Reynolds-Kremer. “Cantering on the track with Gulldís is Kenna’s favorite activity.” We hope to see more young riders on the track next year! *The Division Sponsor was Flying C Tack, and the Championship Prize was a black bridle with white crystal browband and black crystal noseband.*

YOUTH 12-AND-UP DIVISION

CHAMPION: ALICIA FLANIGAN

RESERVE CHAMPION: ISABELLE MARANDA

THIRD PLACE: GRACE STRAUSSER

This was a highly competitive division with

very close results. Alicia Flanigan from Maine was champion with a huge score of 5.9, aboard her brand new mare Brá frá Fellskoti. “Brá is a very opinionated horse and not always very forgiving, so my parents knew she would be a great horse for me to continue to learn and work with,” says Alicia. “I am excited to keep working with her and progressing myself too, so that I am able to ride her to her fullest ability.” The Reserve Champion was Isabelle Maranda from Vermont, scoring 5.71 on her new mare Salvör frá Grafarkoti. She was followed by Grace Strausser from Pennsylvania aboard her young mare, Spurning frá Steinnesi. Both Isabelle and Grace were recognized for their harmonious riding with Featherlight awards throughout the season. *The Division Sponsor was Flugnir Icelandic Horse Association of the Midwest, and the Championship Prize were unique stirrups with rearing horses on the sides.*

GREEN HORSE DIVISION

CHAMPION: HRÖNN FRÁ HÓFGERDI

RESERVE CHAMPION: THOKKI FROM FOUR WINDS FARM

THIRD PLACE: ÍSOLD FROM SOLHEIMAR

FOURTH PLACE: KVIKA FROM FOUR WINDS FARM

FIFTH PLACE: SPURNING FRÁ STEINNESI

This was the most popular division by far, and a unique division in that the horses

(and their owners) were awarded instead of the riders. This encouraged owners to have their young horses trained and shown, even if they didn’t necessarily want to compete themselves. It is extremely exciting to note that out of the top five horses, the majority were domestic bred. The sixth-place horse, Duna from Westerly, was also U.S. bred and finished close behind the fifth-place horse. The champion Green Horse, Hrönn frá Hófgerdi, is a beautiful, tall chestnut mare owned by Léttleiki Icelandics and ridden by both Terral Hill and Sydney Horas this season. Hrönn finished with an average score of 5.55. The Reserve Champion, Thokki from Four Winds, is a domestic-bred gelding who was ridden by his adult amateur owner, Leslie Chambers. “Thokki drew attention for his clean and well separated gaits and harmonious relationship with his rider,” says Carrie Lyons Brandt. The third-place horse, domestic-bred Ísold from Solheimar, was presented by her owner Sigrún Brynjarsdóttir, a professional rider based in Vermont. Kvika from Four Winds Farm, also domestic-bred, is owned by Ron and Sherry Hoover of Beat’n Branch Icelandics. She was presented by Carrie Lyons Brandt this season. The fifth-place horse, Spurning frá Steinnesi, was the only Green Horse to be shown by a youth rider, her owner Grace Strausser. *The Division Sponsor was Aslan’s Country Icelandic Horse Farm, and the Championship Prize were handcarved stone Icelandic horse bookends from Kenya.*



Gabrielle (Elli) Pittman on Svali frá Tjörn. Elli was the champion of the Intermediate Five Gait division. Photo by Shaila Sigsgaard.



MEMBERSHIP APPLICATION

[] New Application [] Renewal

Membership Type: [] Individual [] Family [] Junior

[] Foreign Friend of the US Icelandic Horse Congress

Name:

Address:

City: State/Province : Postal Code: Country:

Phone: Email:

Keep my name and contact information private.

Never use my email address instead of the US Mail to notify me of official USIHC business.

I prefer **not** to receive a copy of the *Quarterly* magazine in the US Mail.

Regional Club:

If you have selected a Family Membership, please complete the following for the second adult and any children to be included in the membership (use the back of the page to add more family members):

Name	Year of Birth (juniors only)	Email (optional)	Enroll in Pleasure Rider Program (optional)

Farm Listing.

Paid members of the USIHC may opt to include a farm listing on the Congress's web site (www.icelandics.org). There is a \$110.00 annual fee for the farm listing in addition to your membership fee.

Farm:

Owners:

Address:

City: State/Province : Postal Code: Country:

Phone: Email:

Fax: Web:

Membership Fees & Restrictions			
Individual	\$45/year. One adult. One vote.	Membership Fee:	\$.....
Family	\$65/year. Two adults and unlimited children living in the same household. Adults vote.	Farm Listing Fee:	\$.....
Junior	\$35/year. One child (under 18 years). Not eligible to vote.	World Championships Donation:	\$.....
<i>Members in the categories above with non-US mailing addresses must be US Citizens</i>		Youth Fund Donation:	\$.....
Foreign Friend	\$70/year. One adult non-US Resident/non-US Citizen with limited benefits. Not eligible to vote.	(optional support for youth programs)	
		Total:	\$.....

Make checks to "USIHC" and mail to the MAIN OFFICE address.

Congress memberships are for one year. Your membership is active on receipt of payment and expires one year later.

MAIN OFFICE: 300 South Sawyer Road, Oconomowoc, WI 53066

Phone: (866) 929-0009 [extension 1]

Email: info@icelandics.org

A brown horse with a thick, wavy mane is running through a snowy field. The horse is captured in profile, moving from left to right. The background is a bright, overcast sky and a snow-covered ground.

THANKS TO YOU
the USIHC Blood Profile Project
is fully funded!

OUR DONORS

Susan Wellington

Doug Smith

Jackie Alschuler

Marilyn Tully

Antje Freygang

Sara Marie Lyter

Melanie Stabler

Elizabeth Haartz

Kristina Behringer

Martin Nielsen

Frances Rospotynski

Christine Schwartz

Kari Pietsch-Wangard

Andrea Barber (in memory of Kalman frá Lækjamóti)

Nancy Adler (in memory of Eloise)

Amanda Halperin (in honor of Magni)

Linda Templeton

Virginia Lauridsen

**Thanks to these donors
for contributing \$12,340!**

**And thanks to all USIHC members
for contributing \$5,000 out of
membership funds.**

**Total amount funded = \$17,340,
which exceeded our \$14,000 goal!**



F A R M L I S T

The owners of the farms listed below have offered to have you visit in order to become acquainted with the Icelandic horse. Some are breeders, some importers, and some are interested in breed promotion alone. Their listing here does not constitute an endorsement of any kind by the USIHC.

CALIFORNIA

Flying C Ranch
Will & Asta Covert
3600 Roblar Ave.
Santa Ynez, CA 93460
(805) 688-1393 (phone)
info@tolt.net
www.tolt.net

Mountain Icelandic Farm
Annette Coulon
620 Calabasas Rd.
Watsonville, CA 95076
(831) 722-8774 (phone)
annette@mountainicelandics.com
www.mountainicelandics.com

Valkyrie Icelandic
Laura Benson
1 Duane St. #33
Redwood City, CA 94062
(650) 281-4108 (phone)
laura@valkyrieicelandic.com
www.valkyrieicelandic.com

COLORADO

Hestar Ranch
Monika Meier-Galliker
P.O. Box 1744 / 30420 C.r. 500
Arboles, CO 81121
(970) 883-2531 (phone)
m.meier@hestar-ranch.us
www.hestar-ranch.us

Lough Arrow Icelandics
Andrea Brodie, D.v.m.
22242 County Road 46.0
Aguilar, CO 81020
(719) 680-2845 (phone)
fiddlinvet@gmail.com
www.coloradoicelandics.com

Tamangur Icelandic Horses
Coralie Denmeade
P.O. Box 2771
Monument, CO 80132
(719) 209-2312 (phone)
coralie@tamangur-icelandics.com
www.tamangur-icelandics.com

FLORIDA

Florida Icehorse Farm
Beerihomes Llc
10551 Deal Rd
North Fort Myers, FL 33917
(239) 223-5403 (phone)
floridaicehorsefarm@gmail.com
www.floridaicehorsefarm.com

IOWA

Harmony Icelandics
Virginia Lauridsen
1401 Casady Dr.
Des Moines, IA 50315
(515) 556-3307 (phone)
virginia@harmonyicelandics.com
www.harmonyicelandics.com

KENTUCKY

Lettleiki Icelandics
Maggie Brandt
6105 Eminence Pike
Shelbyville, KY 40019
(502) 541-4590 (phone)
maggie@lettleikiicelandics.com
www.lettleikiicelandics.com

Taktur Icelandic Horses
Terral Hill & Carrie Lyons Brandt
12501 W Hwy 42 Apt B
Prospect, KY 40059
(502) 409-1924 (phone)
carrieandterral@gmail.com
taktur.horse

MAINE

Boulder Ridge Farm
Brian & Cindy Wescott
1271 Cape Rd
Limington, ME 04049
(207) 637-2338 (phone)
info@bricelandics.com
www.bricelandics.com

Grand View Farm
Charles & Peggy Gilbert
137 North Road
Dixmont, ME 04932
(207) 257-2278 (phone)
(207) 941-9871 (fax)
grandviewfarm@midmaine.com

NEW MEXICO

Windsong Icelandics
Ulla Hudson
P.O. Box 918
733 State Road 344
Edgewood, NM 87015
(505) 615-5050 (phone)
(505) 286-7791 (fax)
ullahudson@mac.com
windsongdressage.com/windsongicelandics.com/windsongtack.com

NEW YORK

Sand Meadow Farm
Steven & Andrea Barber
300 Taylor Road
Honeoye Falls, NY 14472
(585) 624-4468 (phone)
toltstar@yahoo.com
www.sandmeadow.com

NORTH CAROLINA

Hulinndalur
Sara Lyter
372 John Weaver Rd
Columbus, NC 28722
slyterz@yahoo.com

OHIO

Beat'n Branch Icelandics
Ron & Sherry Hoover
4709 Beat Rd
Litchfield, OH 44253
(330) 667-2879 (phone)
890hoover@gmail.com

Common Ground Farm and Kennel
Jim and Laurie Blakey
12698 Mantua Center Rd.
Mantua, OH 44255-9368
(330) 995-9273 (phone)
commongroundfarmandkennel@gmail.com
poodlepony.com

Cytraas Farm
John R. Haaga
Call For Appointment
Chagrin Falls, OH 44022
(216) 464-7260 (phone)
ellenhaaga@gmail.com
www.cytraas.net

OREGON

Five-Gait Farm Icelandics- Breeding and Training
Lucy Nold
86623 Central Road
Eugene, OR 97402
(831) 332-5328 (phone)
fivegaitfarmicelandics@gmail.com
fivegaitfarm.com

Schwalbenhof
Karin Daum
10676 Nw Valley Vista Rd
Hillsboro, OR 97229
(503) 724-9537 (phone)
daumkarin@gmail.com



PENNSYLVANIA

Meant To Be Farm
Juli & Steve Cole
109 Germanski Lane
New Castle, PA 16102
(724) 667-4184 (phone)
juli2875@yahoo.com
www.meanttobefarm.com

SOUTH CAROLINA

Black Creek Farm
Sarah C. Elkin
449 Jewell Boone Rd.
Pelion, SC 29123
(803) 894-4514 (phone)
bigdoglady@pbtcomm.net
blackcreekfarm.us

SOUTH DAKOTA

Morning Star Farm
Margaret Hillenbrand
6758 Nameless Cave Road
Rapid City, SD 57702
(605) 381-4956 (phone)
hillenbrandmimi@gmail.com

VERMONT

Silver Maple Icelandic Horse Farm
Susan Peters
106 Gilley Road
Tunbridge, VT 05077
(802) 889-9585 (phone)
susan.peters@gmail.com
www.silvermapleicelandics.com

WASHINGTON

Evans Farm-Orcas Island
Wanda & John Evans
P.O. Box 116
Olga, WA 98279
(360) 379-4961 (phone)
evansfarm@orcasonline.com
www.icelandichorsesnorthwest.com

Five-Gait Farm Icelandics
Young Horse and Retirement Boarding
Jennifer Denning and K.C. Thornley
15 Foster Lane
Centerville, WA 98613
(831) 332-5328 (phone)
fivegaitfarmicelandics@gmail.com
fivegaitfarm.com

Lone Cedar Icelandic Horses
Dawn Shaw
P.O. Box 524
451 E. Murray Road N
Grapeview, WA 98546
(360) 275-7542 (phone)
iceherd@hotmail.com
www.lonecedaricelandichorses.com

Red Feather Icelandic
Dick and Linda Templeton
24 Whitewater Drive
Trout Lake, WA 98650
(541) 490-0975 (phone)
redfeathericelandics@gmail.com
www.redfeathericelandics.com

WEST VIRGINIA

Deep Creek Farm
Curtis Pierce and Marsha Korose
537 Fjord Rdige Dr
Mathias, WV 26812
(304) 897-6627 (phone)
cepinwv@yahoo.com
www.deepcreekfarm.com

Icelandic Thunder
Denise & James Taylor
550 Hackers Creek Rd
Philippi, WV 26416-7198
(304) 457-4238 (phone)
icywoman@msn.com
icelandicthunder.com

WISCONSIN

Winterhorse Park Icelandic Horse Farm
Barbara and Daniel Riva
S75 W35621 Wilton Rd.
Eagle, WI 53119
(262) 594-5152 (phone)
(262) 594-2720 (fax)
winterhorse@centurytel.net
www.winterhorse.com

YOUR AD HERE

Your advertising
SUPPORT
helps to keep
the Quarterly
COLORFUL!
contact us at:
quarterly@icelandics.org

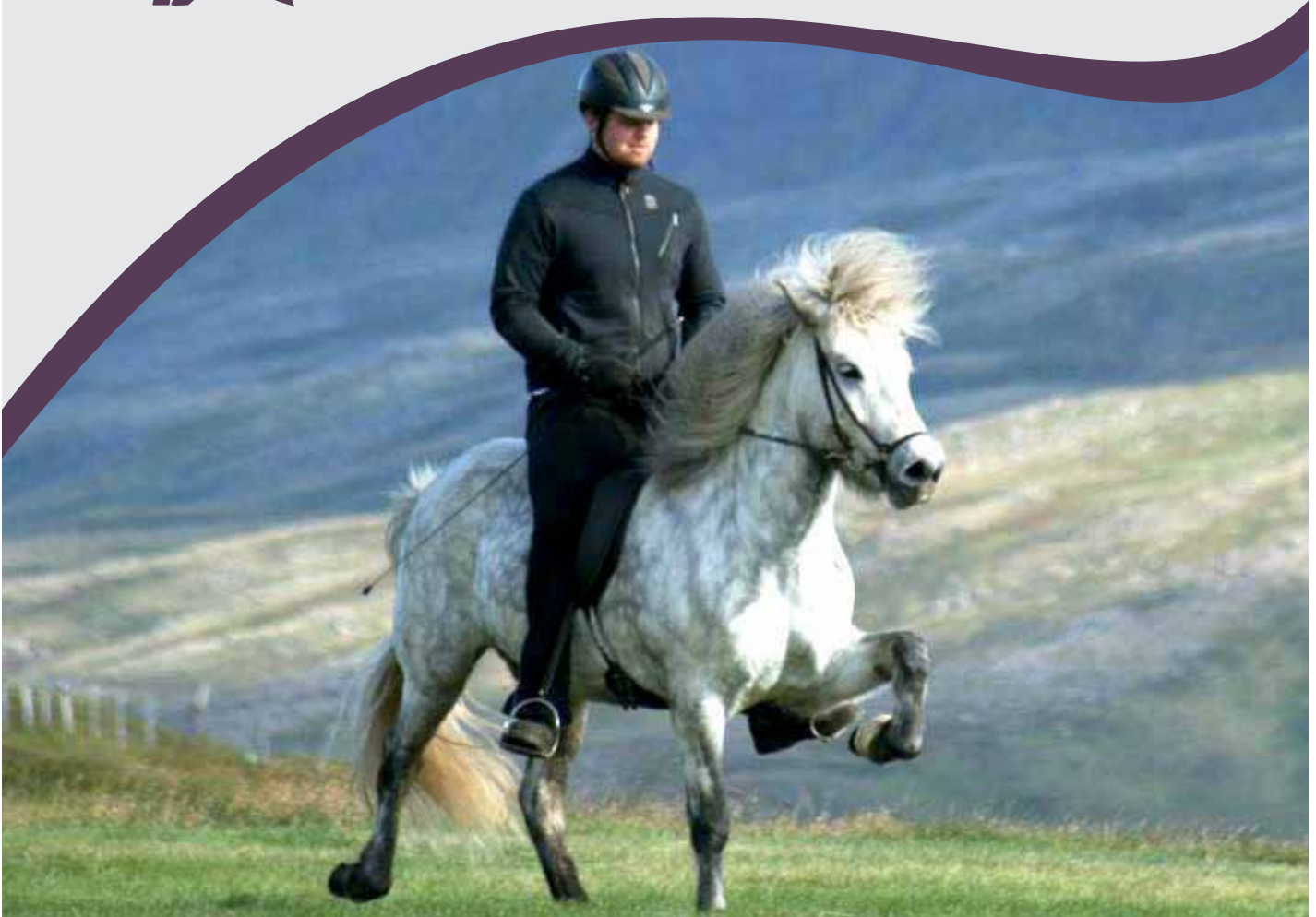

LESSONS • TRAINING • SALES • BREEDING • IMPORTS

WWW.HARMONYICELANDICS.COM

For more information contact Virginia@HarmonyIcelandics.com

2017 TRIP CALENDAR

Educate & Rejuvenate

TAUGHT BY GUDMAR PETURSSON & FOR ALL LEVELS

JUNE 9-15 & JULY 1-7

OUR MOST POPULAR TRIP

RIDING CLINIC & SIGHTSEEING HORSE RIDING CAMP FOR ADULTS

Sagas & Vikings

OPTIONAL RIDING

MAY 26-JUNE 1

A HISTORICAL TRIP HOSTED BY **NANCY MARIE BROWN**



www.america2iceland.com

LIMITED SPACE • **NOW ACCEPTING CREDIT CARDS**

(828) 348-4257 • INFO@AMERICA2ICELAND.COM



Tolt In Style

with Toltable Tees



Styles for Men & Women
Order online at ToltableTees.com

BOOKS ON ICELAND

sagas • history • culture • horses

NANCYMARIEBROWN.COM

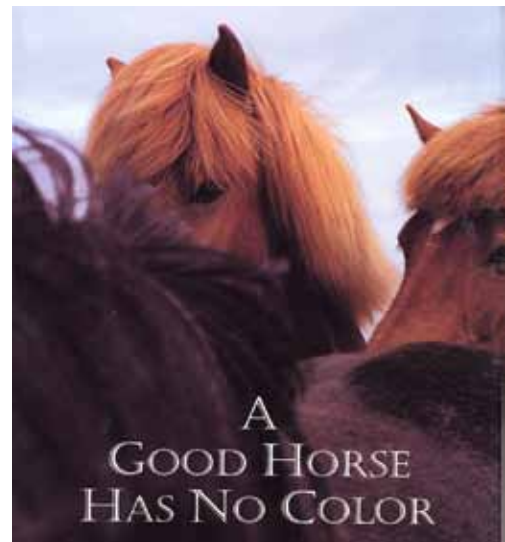

AMERICA2ICELAND.COM

for riders and non-riders

TOURS TO ICELAND

RIDING TOURS IN ICELAND

WWW.RIDINGTOURSICELAND.COM



COME RIDE WITH
GUDMAR PETURSSON

CUSTOM RIDES

EXPERT GUIDES

tölt
tassels



www.tolttassels.com



Léttleiki

ICELANDICS

Léttleiki Icelandics, LLC Icelandic Horse Center
for Training, Education, Sales, & Breeding

www.lettleikiicelandics.com

"Feed," by Lon Brauer

